

Product Catalog

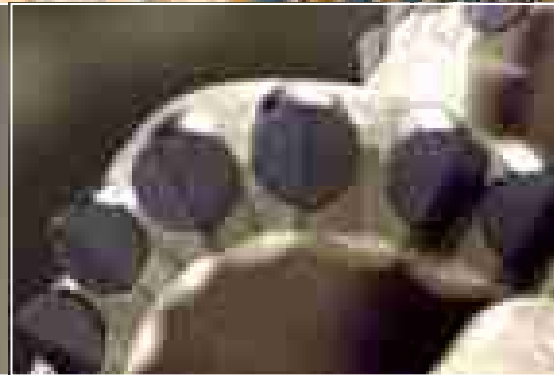
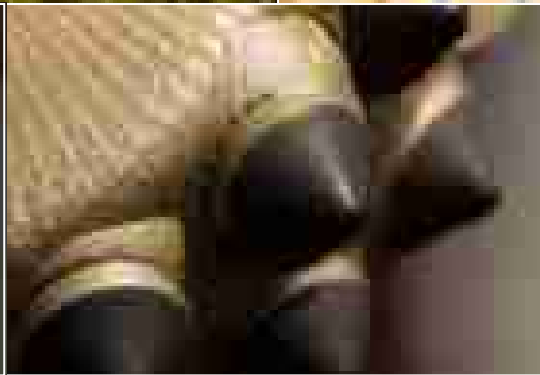
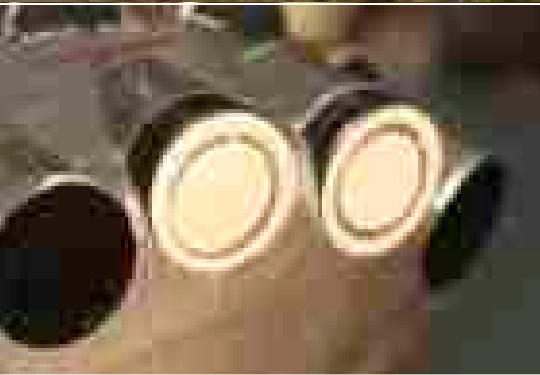

SMITH BITS
A Schlumberger Company

Copyright © 2018 Schlumberger. All rights reserved.

No part of this book may be reproduced, stored in a retrieval system, or transcribed in any form or by any means—electronic or mechanical, including photocopying and recording—without the prior written permission of the publisher. While the information presented herein is believed to be accurate, it is provided “as is” without express or implied warranty.

Specifications are current at the time of printing.

17-BDT-310907

An asterisk (*) is used throughout this document to denote a mark of Schlumberger. Other company, products and service names are the properties of their respective owners.

Table of Contents

Technological Expertise.....	5
Innovative Smith Bits technology for every stage of drilling	
New Technology Bits.....	17
Unique cutter geometries for improved performance	
Fixed Cutter Products.....	23
Wide range of PDC and diamond-impregnated bits	
Roller Cone Bits.....	39
Comprehensive selection for various applications	
Percussion Hammers.....	55
Impax* diamond-enhanced insert hammer bit products	
Specialty Applications.....	61
Reference Guide.....	69



Technological Expertise

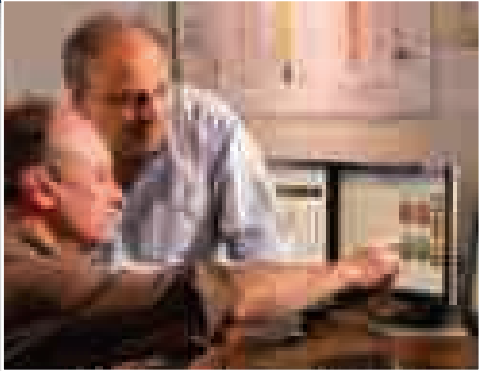

Technological Expertise

Analysis, optimization, and support for every stage of the drilling program — from planning to execution

Engineering and modeling

- IDEAS* integrated dynamic design and analysis platform
- Computational fluid dynamics (CFD) analysis
- i-DRILL* integrated dynamic system analysis service
- Advanced services engineering (ASE)
- DBOS* drillbit optimization system
- YieldPoint RT* drilling-hydraulics and hole-cleaning simulation program
- DRS* drilling record system



Roller cone technology

- Hydraulics
- Inserts



Diamond-impregnation technology

- Grit hot-pressed inserts (GHIs)



Engineering and Modeling

IDEAS integrated dynamic design and analysis platform

Application-specific drill bits with higher performance and greater reliability

The IDEAS platform uses advanced simulation and modeling to design and certify every new Smith Bits drill bit. It has five basic elements that enable it to optimize bit performance.

Comprehensive drilling system analysis

The design process takes into account the effects of the lithology at the rock-cutter interface, drillstring, drive system, individual BHA components, and total system on bit behavior in a dynamic drilling environment. It also takes into account the specific operating parameters and the interaction between individual elements of the drilling assembly.

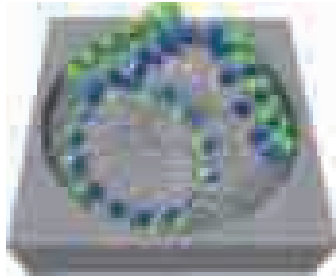

Holistic design process

Smith Bits design engineers account for every critical variable. Virtually every cone or cutter position is selected to create a stable bit that rotates around its center—a key requirement for efficient drilling.

Application-specific enhancements

Continuous improvement results in fit-for-purpose bits that consistently outperform previous designs when measured against the same parameters—for example, ROP, durability, and specific bit behavior with a rotary steerable system. Drill bits that are certified by the IDEAS platform are dynamically stable within the operating envelope for which they are designed, leading to longer bit runs and less stress on the BHA.

Each certified bit undergoes rigorous design evaluation and testing to produce a detailed application analysis of how it will perform for a specific drilling program.

Rapid solutions with reliable results

By using sophisticated modeling tools and accounting for a multitude of dynamic variables in a virtual environment, the IDEAS platform moves bits through the design process much quicker while ensuring better reliability and performance than ever before. The traditional trial-and-error approach is replaced by laboratory tests and simulations to quantify variables such as cutter forces and rock removal rates.

Advanced material integration

Stronger and more durable advanced cutter materials are used more effectively by working in conjunction with IDEAS platform capabilities. The resulting bit has abrasion- and impact-resistant cutters and an optimal design for high performance.

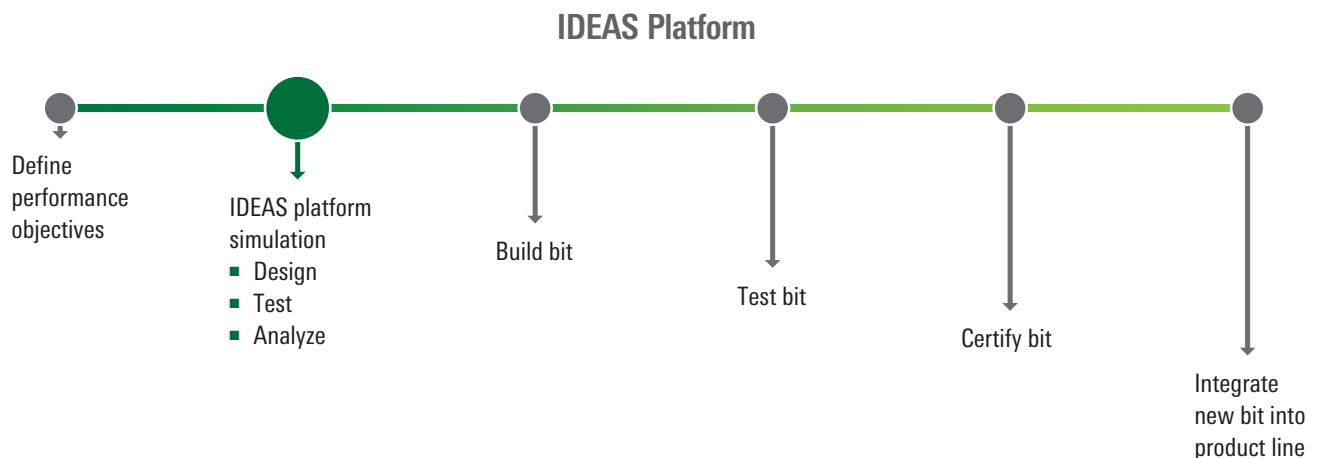

IDEAS platform eliminates the costly and time-consuming trial-and-error methods of the traditional drillbit design process, enabling Smith Bits to deliver a better solution faster.

Engineering and Modeling

IDEAS platform certification for directional applications

Improved performance, reduced risk, and insight to keep directional wells and drilling budgets on target

Extensive analyses of drill bits designed for directional applications using the IDEAS platform shows that a single design can provide exceptional performance with a variety of directional drilling systems, if it is dynamically stable. Often, the range of special features incorporated into conventional directional bits merely allows an intrinsically unstable bit design to drill acceptably for a specific application. If the bit is subsequently used with a slightly different BHA or in a different application, it becomes unstable, and a new or significantly modified bit is required.

Bits for directional drilling that have IDEAS platform certification remain stable and provide superior performance with different types of steering systems in a wide range of applications. Changing the system configuration or operating parameters does not diminish the performance of the bit. Drilling with a stable bit reduces costs and equipment failures in addition to providing a smooth, high-quality wellbore.

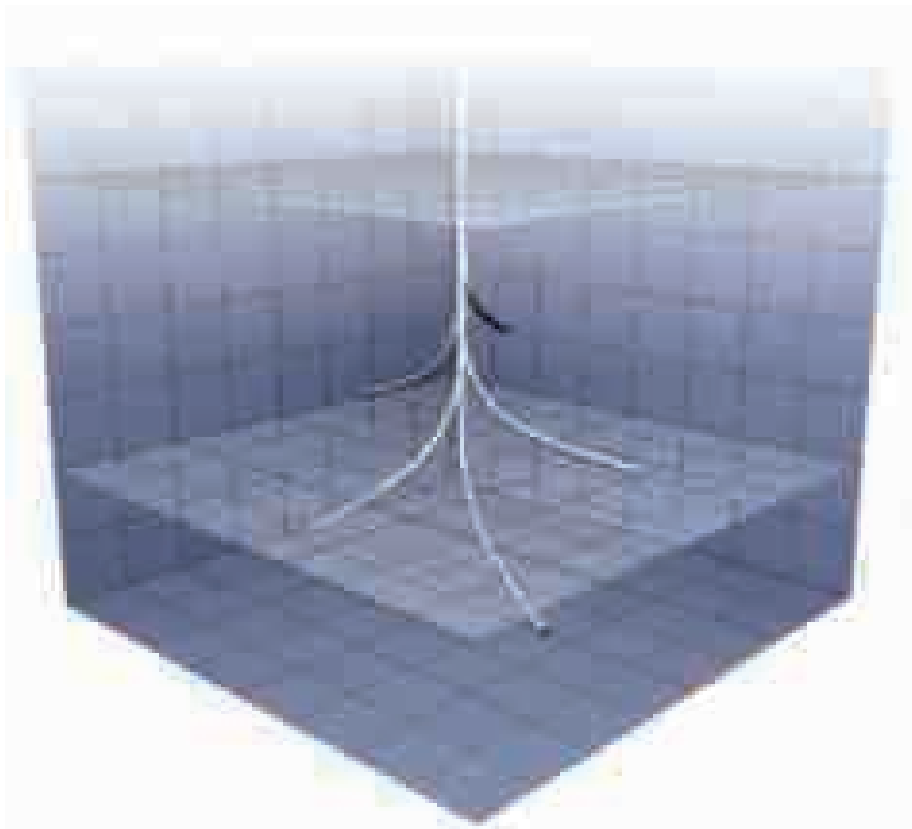

Engineering and Modeling

Computational fluid dynamics (CFD) analysis

Efficient hydraulics for improved performance and lower drilling costs

Smith Bits design engineers use CFD to model the interaction of drilling fluids with the bit and the wellbore. Complex algorithms enable the simulation of a wide variety of downhole conditions, allowing engineers to evaluate various blade and nozzle configurations to optimize flow patterns for cuttings removal. Ensuring the cutting structure is always drilling virgin formation improves bit performance. Extensive use is made of this sophisticated technique to maximize the available hydraulic energy, providing bits that will drill at the lowest-possible cost per foot.

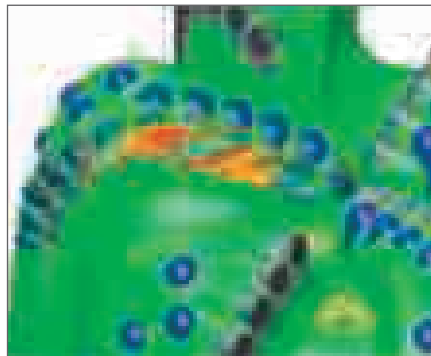
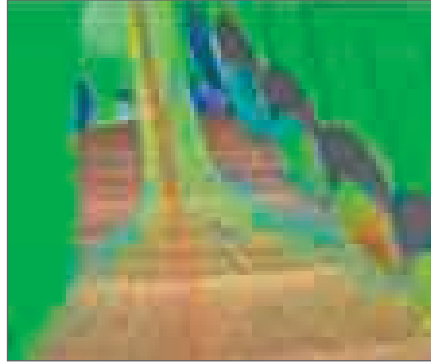

Using CFD to visualize flow patterns enables designers to analyze how design modifications affect bit performance and choose the optimal solution.



Engineering and Modeling

i-DRILL integrated dynamic system analysis service

Maximized performance with a dynamically stable drilling assembly

i-DRILL service uses predictive modeling to identify solutions that minimize vibrations and stick/slip during drilling operations, and optimize BHA performance for a given environment. Specially trained engineers simulate the behavior of the bit as well as each component of the BHA and the drillstring. They evaluate a range of options to reduce harmful vibrations, thus increasing equipment life, minimizing failures, increasing ROP, improving hole condition and directional control, and decreasing overall drilling cost. Various combinations of drillbit options, drilling assembly components, drillstring designs, surface parameters, component placement, and overbalance pressures can be examined for the specific lithology. Advanced graphics capabilities illustrate the results with clarity.

Simulation eliminates trial and error

The i-DRILL service enables quantification of vibration and ROP produced by a virtual drilling system as a function of time. This is accomplished by combining a bit-drilling-rock model with a finite-element analysis (FEA) of the bit and drillstring.

Analyzing the dynamics of the drilling assembly through multiple formations of variable compressive strength, dip angle, homogeneity, and anisotropy helps obtain optimal performance through formation transitions. Virtual testing of new technology and unconventional approaches eliminates the risk and expense of trial and error on the rig.

Diverse data sources improve accuracy

Using offset well data, surface and downhole measurements, and a thorough knowledge of products and applications, Smith Bits experts create a virtual drilling environment with the i-DRILL service. Detailed geometric input parameters and rock mechanics data are also taken into account. Simulating the drilling operation enables evaluation of the root causes of inefficient and damaging BHA behavior.

i-DRILL service capabilities

- Identify the true technical limit of performance without risking lost rig time associated with exceeding the limit or inefficiencies resulting from operating too far below the limit
- Eliminate unnecessary trips to change BHAs when trying to identify the optimal drilling system
- Predict the performance of new drillbit designs
- Predict the dynamic behavior of directional BHAs in space and time
- Identify weak areas in the drillstring and BHA to help prevent the loss of tools downhole
- Minimize harmful lateral, torsional, and axial vibrations and stick/slip through the selection of dynamically stable drilling assemblies
- Balance drillbit and underreamer cutting structure loading to maximize dual-diameter BHA stability
- Develop improved drilling program schedules with reduced risk of unplanned delays

i-DRILL service analyses

- Drilling system check to evaluate dynamic behavior; identify issues with vibration, bending moments, and torque; and select the optimal system
- Bit analysis to identify the design that will yield the highest ROP under stable conditions
- Bit durability and ROP through different formations

- Bit-underreamer balance to determine the combination that will result in the highest ROP under stable conditions
- BHA comparison to investigate directional behavior while minimizing vibrations
- Range of WOB and drillbit rpm for maximum ROP under stable conditions
- Postwell follow-up to determine usage and effectiveness of prewell i-DRILL service recommendations

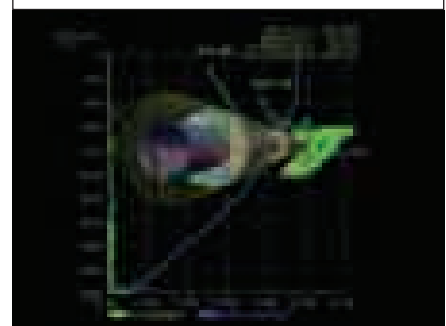
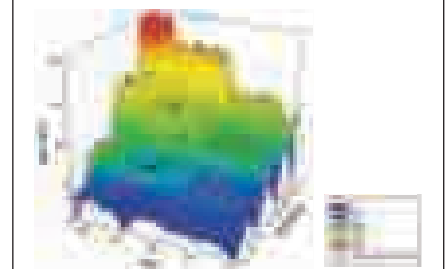
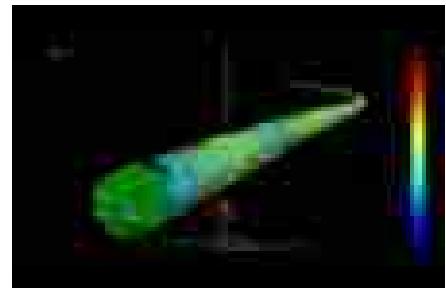

The i-DRILL service integrates real data from various sources to accurately predict the downhole behavior of bits.

Engineering and Modeling

Advanced services engineering (ASE)

In-house bit recommendations and operational advice

The ASE team has an established track record of lowering drilling costs through improved performance by recommending the ideal bit for the application—a vital aspect of a comprehensive well plan. Bit recommendations and operational advice are based on the technologies and operating parameters best suited for a particular application.

Expert drillbit selection

The ASE group provides an experienced bit application specialist for the customer's drilling team to deliver engineered bit recommendations and advice to both the operator and the service providers on the day-to-day requirements for maintaining superior bit performance. ASE personnel consider the entire drilling environment, including the formation, the components of the BHA, drilling fluids, rig capabilities, rig crew, and any special drilling objectives in their search for the optimal bit and subsequent maintenance of its efficiency throughout its life.

The engineer uses several proprietary tools, such as the

- DRS drilling record system, which includes detailed bit runs from oil, gas, and geothermal wells around the world
- DBOS drillbit optimization system, which helps determine the appropriate combination of cutting structure, gauge protection, hydraulic configuration, and other bit optimizing features
- YieldPoint RT drilling-hydraulics and hole-cleaning simulation program for jet nozzle optimization.

Optimized drilling plan

The DBOS program uses knowledge gained from DRS system analysis of offset wells and a spectrum of other relevant information. It provides a thorough formation analysis, rock strength analysis, and both roller cone and fixed cutter bit selections.

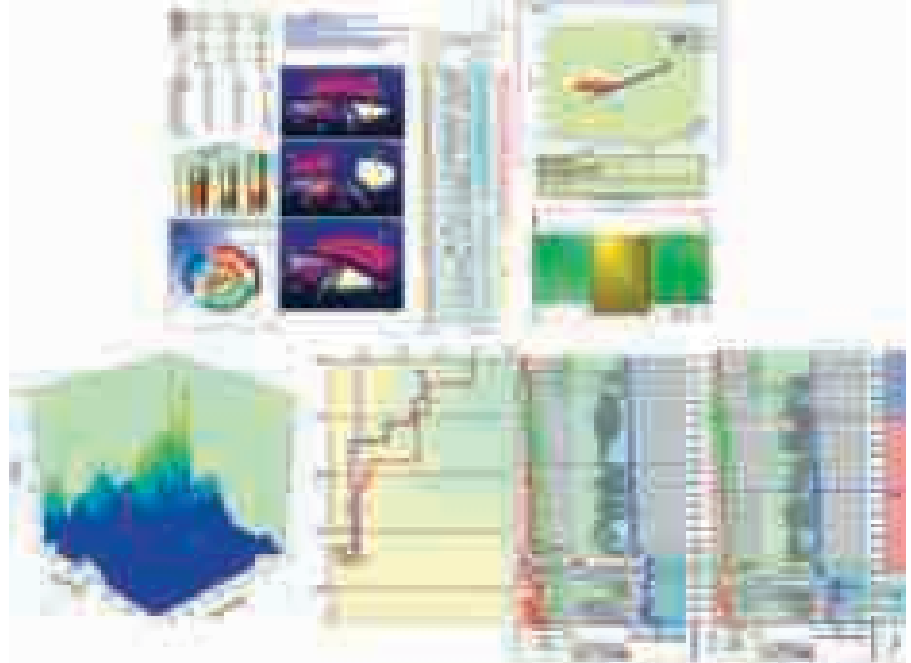

Detailed graphical displays help engineers optimize drilling plans and minimize risks.

The YieldPoint RT program creates a graphical user interface to aid drilling engineers in specifying mud types and properties that satisfy rheological models of drillstrings and well annuli. The software can answer questions about hole cleaning with data from the formations to be encountered. Using a cuttings transport model, the program can help assess potential hole-cleaning difficulties during the well planning stage, thus minimizing problems during actual drilling operations.

Operational needs and the well plan are also taken into consideration, including casing points and hole sizes, well directional plot, and expected formation tops. The result is an optimized minimum-cost-per-foot program, often with multiple options and alternatives.

Continuous evaluation while drilling

To establish measurable goals, the ASE expert prepares a comprehensive plan. During drilling, performance is evaluated continuously against this plan.

The appropriate rig and office personnel are briefed on the drilling program and monitor the well prognosis during implementation of the well plan. Unexpected performance or events that arise are identified and investigated, and decisions are made to correct the issues subject to the objective of maintaining peak drilling efficiency and safety.

Engineering and Modeling

Advanced services engineering (ASE)

Postwell analysis

A thorough performance assessment is conducted upon completion of the well, evaluating every part of the drilling operation. The ASE expert, as part of the drilling team, makes recommendations for improvements related to bit selection and drilling for future well plans.

The ASE team provides value by recommending the best bit for the specific application, which will deliver the most efficient and economical drilling performance.

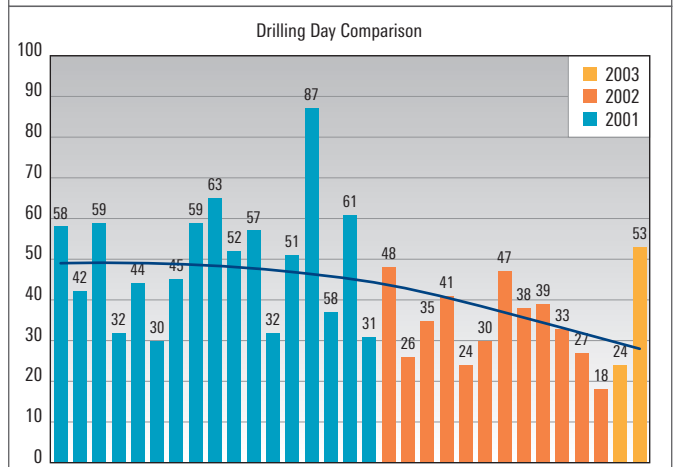
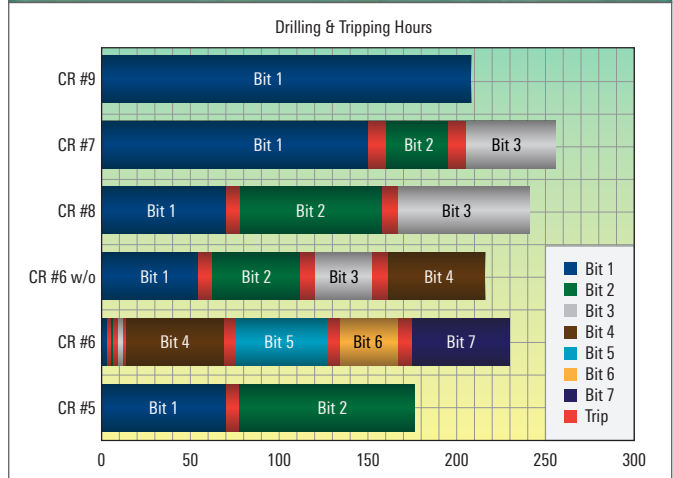
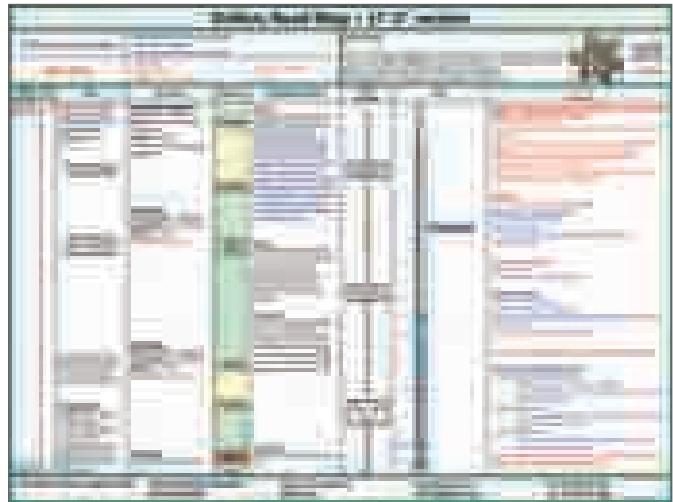

Comprehensive prejob analysis, simulation and planning maximize efficiency and economy on location.

Engineering and Modeling

DBOS drillbit optimization system

Comprehensive analysis to optimize interval cost per foot

To achieve the minimum cost per foot with a higher degree of certainty and reduced risk, the DBOS system identifies the best drill bit for the interval to be drilled. This software-based system uses offset well data to choose a fixed cutter, roller cone, or turbodrill drill bit that has the appropriate combination of cutting structure, gauge protection, hydraulic configuration, and other critical characteristics.

Since its inception, the DBOS system has provided significant cost and time savings for operators around the world while creating a supporting database of more than 20,000 wells. The system incorporates a thorough analysis of offset well data, including well logs, formation tops, mud logs, core analysis, rock mechanics, drilling parameters, drillbit records, and dull bit conditions.

DBOS system comprises

- petrophysical log analysis program
- proprietary algorithms for rock compressive strength, drillbit performance analysis, and drillbit selection
- well log correlation and statistical analysis software
- geologic mapping program.

The flexibility of the system allows engineers to analyze various levels of information and deliver a bit strategy based on input from a single offset well, multiwell cross section, or full-field mapping and regional trend analyses.



DBOS system evaluation process

1. Evaluation of expected formation types and their section lengths from offset logs
2. Determination of unconfined compressive strength, effective porosity, abrasion characteristics, and impact potential
3. Identification of one or more potentially optimal bit types and applicable features
4. Prediction of the cost per foot for each bit and configuration
5. Drillbit selection for planned hole

Operator deliverables

Various levels of analysis are offered. For each level, data is presented graphically in log plot form and statistically in the interval analysis plots. The analysis evaluates key bit performance variables over the given intervals, identifying which bit will be the most successful for drilling through specific single intervals or over multiple intervals, based on experience data and the knowledge-based heuristics.

Parallel analysis for roller cone bit options, PDC bit applications, and high-speed turbodrilling options are all considered. The final proposed bit program combines this input for optimized interval cost per foot.

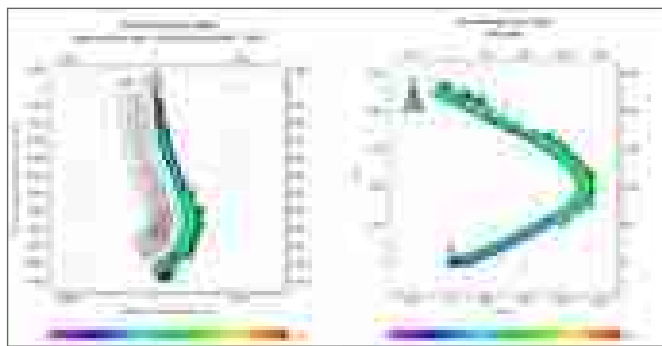

DBOS system integrates data from logs, directional surveys, offset wells, and other sources to optimize bit selection.

Engineering and Modeling

DBOS drillbit optimization system

Input parameters include

- drillbit record information
- directional surveys
- real-time ROP and mud log data
- wireline or LWD formation evaluation data
- rock type and strength data
- hydraulic and mechanical energy factors.

Neural networks, planned run simulation and real-time optimization

Neural networks have been used in DBOS system operations for synthetic log generation since 1997 and serve as the principal modeling for on-time, real-time drillbit optimization. Artificial neural networks (ANNs) have proven accuracy in generating synthetic logs (used primarily for sonic log generation) with R^2 (goodness of fit) values in the high 90 percentiles compared with traditional offset correlation methods. Neural networks provide system response characteristics, valuable in nonlinear multi-input solution.

Real-time applications

Drillbit performance in terms of ROP and dull grade can be predicted prior to drilling in run simulations. In predrilling simulations, drilling systems can be tested in advance to find the most efficient way to drill.

Optimized drilling parameters can be assessed and delivered to the driller and rig floor in real time, giving predictions ahead of the bit. The results can be monitored with respect to improved ROP, longer drillbit life, or reduced downhole shock and vibration. DBOS system has contributed to improvements in bit run performance on the order of 20% to 40% or better in ROP, longer bit life, and reduced incidents of drillbit-related failures.

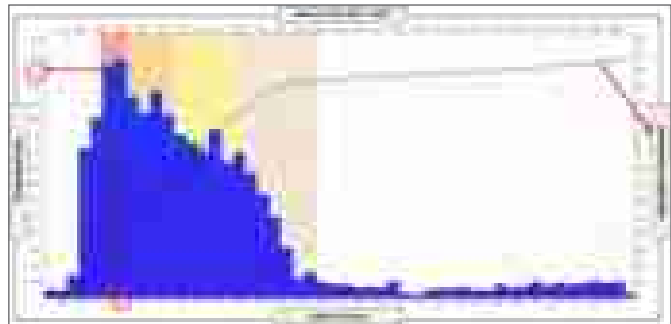
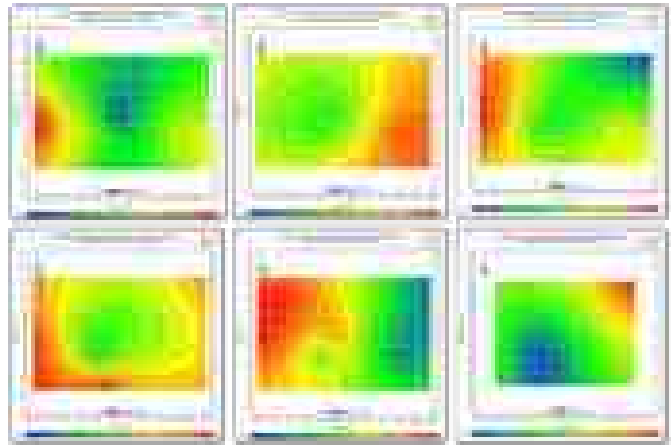

Real-time optimization improves run performance, bit life, and overall drilling risk.

Engineering and Modeling

YieldPoint RT drilling-hydraulics and hole-cleaning simulation program

Optimized hole-cleaning solutions to save time and costs during drilling

The YieldPoint RT program identifies potential problems with hole cleaning in the planning stage rather than during drilling operations when they can have a significant impact on the cost of the well. It aids drilling engineers in specifying mud type and properties to satisfy rheological models of drillstrings and well annuli.

This comprehensive program uses sophisticated algorithms to deliver solutions for conventional jet nozzle optimization and selection. It creates simulations of mud properties, flow rate, ROP, and total flow area. The virtual model then demonstrates the effects on observed bit hydraulic factors and on hole cleaning.

Diverse inputs for real-time assessment

YieldPoint RT program allows data to be input and retrieved via an Internet connection and the Web-based wellsite information transfer standard markup language (WITSML) by authorized wellsite providers and off-location users such as

- well operator
- drilling contractors
- mud loggers
- rig instrumentation and wireline companies
- drilling fluid service companies
- casing running service providers
- directional drillers
- drilling and exploration engineers and managers
- reservoir engineers
- management personnel
- seismic survey companies
- process optimization consultants
- materials suppliers.

Wellsite service providers can contribute expertise to the common store via the WITSML interface and then query the data store for combined information from other wellsite services. This information can support program analysis, visualization, and potential corrective actions, thereby enabling real-time drilling and production decisions. Hydraulics can be optimized to maximize efficiency as the well is being drilled.

Operating company personnel can compile information from any mix of vendors, view and monitor current wells via Web-based applications, and extract reports at any time. The result is a real-time solution that substantially reduces costs.

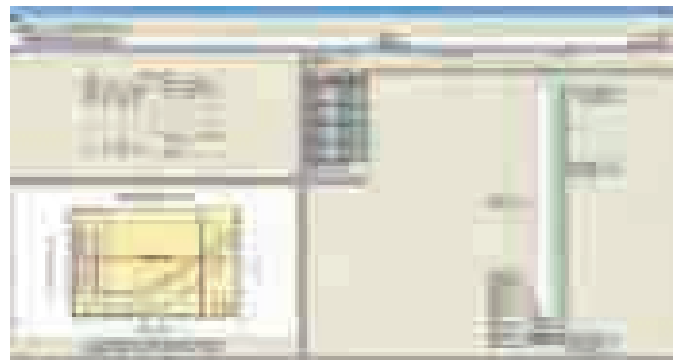
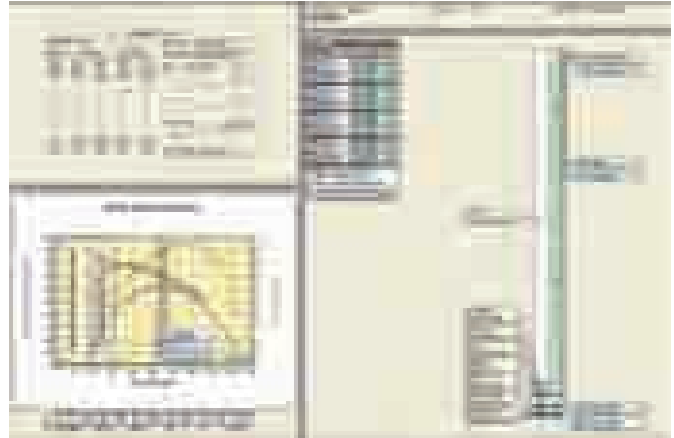

Simulations can identify potential hole cleaning problems before they interrupt the drilling program, and provide real-time optimization to maximize drilling efficiency.

Engineering and Modeling

DRS drilling record system

Extensive library of bit run information to help improve drillbit selection

The Smith Bits DRS drilling record system is a collection of nearly millions of bit runs from virtually every oil and gas field in the world. The database was initiated in May 1985, and since that time, records have been continuously added for oil, gas, and geothermal wells. With this detailed data and the capabilities of the IDEAS platform, Smith Bits engineers can simulate bit performance and make changes to their bit designs to optimize performance in a specific application.

In addition, the system enables the DBOS system to ensure that the right bit is run in a given formation. With this plan in place prior to drilling the well, customers are able to reduce risk, lower drilling costs, and shorten the total time required to drill their wells.

The inclusion of bit record data from the customer wells in the DRS system contributes to better drillbit selection and application for your drilling program. The system can be accessed through Smith Bits applications engineers or sales representatives.

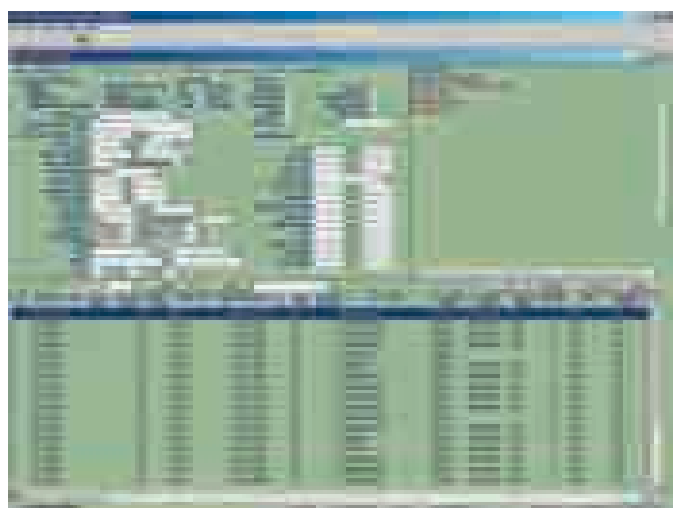
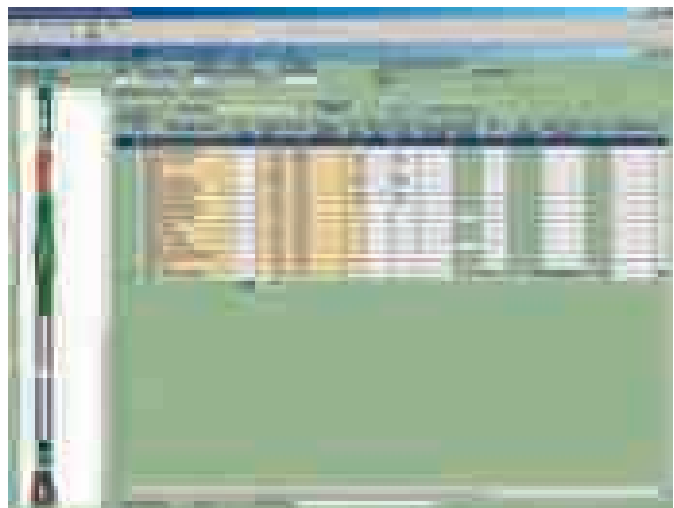
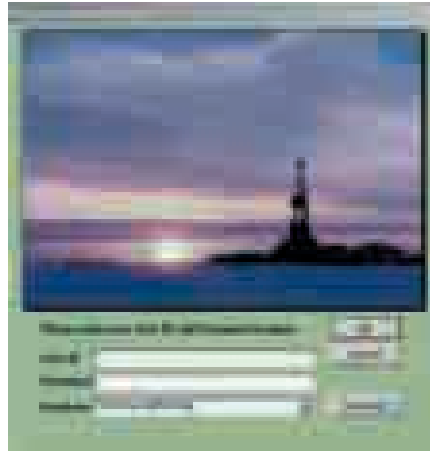

With millions of bit-run records, the DRS system contributes to continuous drilling improvement efforts.

New Technology Bits

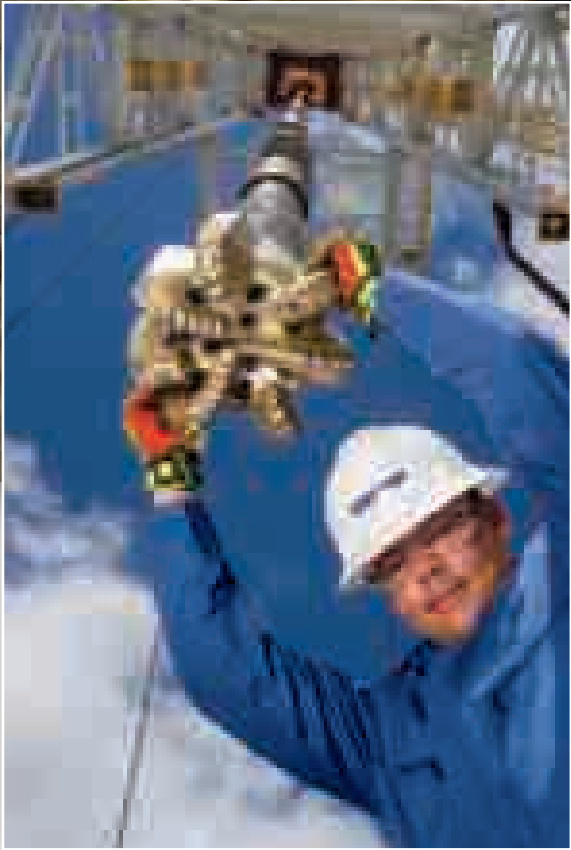

PDC Bits with Central Stinger Element

Beyond shear performance

Innovative conical diamond element increases drilling speed and improves stability

PDC bits fitted with a central Stinger* conical diamond element maintain superior impact strength and wear resistance due to an innovative cutting structure. Located at the bit's center, the element enables high-point loading to fracture rock more efficiently for increased ROP, longer and faster runs, better steerability and stability, and larger cuttings across a wide range of applications.

In field tests comparing conventional PDC bits and PDC bits fitted with a Stinger element in various rock types and operating parameters, bits with a Stinger element demonstrated greater durability and stability while increasing ROP as much as 46%.

Optimized cutting structure answers borehole center challenges

Because the rotational velocity of conventional PDC cutters decreases with their proximity to the center of the cutting structure, they are least effective at removing rock from the center of the borehole, especially in hard formations. And, because center cutters bear the highest load, operational and formation changes can cause destructive lateral vibrations and cutter damage.

Using the IDEAS platform, bit designers shortened the blades that held the PDC bit's low-velocity center cutters. The absence of these cutters allows a stress-relieved column of rock to develop while drilling, which the center-placed Stinger element continuously crushes and fractures, thereby improving drilling efficiency. The stability demonstrated by bits with a Stinger element is a positive dynamic that improves borehole.



The Stinger element combines a unique conical geometry with synthetic diamond material that is engineered to provide impact strength and superior resistance to abrasive wear.

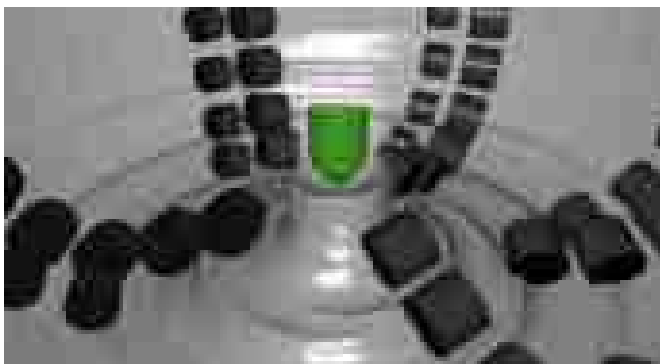

By reconfiguring the bit with the Stinger element, a column of rock is allowed to form at the center of the cutting structure, which is continuously crushed and fractured, increasing drilling efficiency.



StingBlade bit.

PDC Bits with ONYX 360 Cutters

A revolution in PDC bit durability

Revolutionary cutting technology extends PDC bit durability

PDC bits with ONYX 360* rolling PDC cutters substantially increase bit durability with cutters that revolve 360°. Positioned in the highest wear areas of the cutting structure, the ONYX 360 cutter's entire diamond edge is used to drill the formation. The cutter's rotating action allows the cutter's diamond edge to stay sharper longer, extending ONYX 360 cutter life far beyond that of premium fixed cutters.

When compared with fixed-cutter-only bits, PDC bits that included ONYX 360 rolling cutters demonstrated run length increases of up to 57%, resulting in fewer bit trips and lower drilling costs.

Unique rolling cutter design ensures reliability

Considering a PDC bit's cutting structure, Smith Bits engineers developed a specialized integrated housing for a rolling cutter, which is brazed into the bit blade. This design encloses and secures the cutter while allowing it to rotate.

Using the IDEAS platform, bit engineers determine the optimal rolling cutter orientation in the blade relative to its contact with the formation. This precise positioning, coupled with the bit's drilling force, drives efficient rotation of the cutter. Because the entire diamond edge of the cutter is used, wear is reduced for more sustained rates of penetration.



The ONYX 360 cutter's shaft is fully contained within an integrated housing to ensure continuous rotation and cutter retention during drilling.

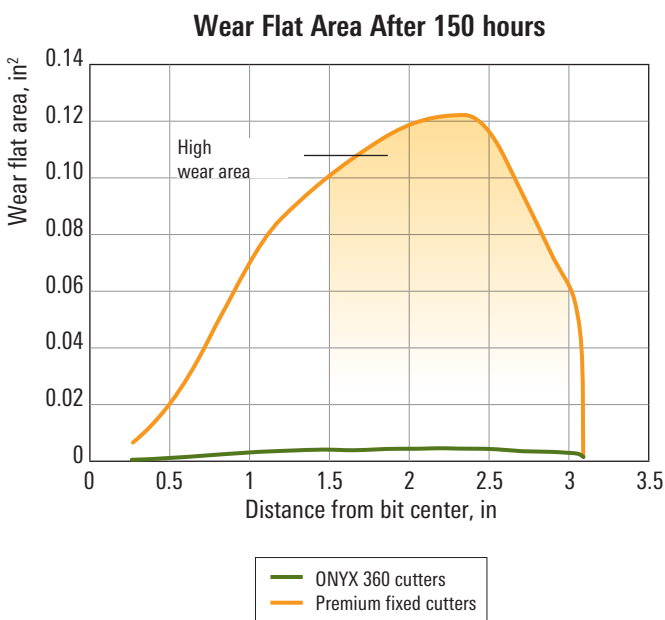

In abrasive formations, the bit's shoulder area (between the center of the cutting structure and gauge) is where cutters typically experience the greatest amount of wear. The ability of the IDEAS platform to predict the degree and precise location of this wear makes it an invaluable design tool.



PDC bit with ONYX 360 cutters.

StingBlade Bit

Superior performance in hard-to-drill applications

Fewer vibrations for longer runs at higher ROPs

The StingBlade* conical diamond element bit leverages the unique 3D geometry of Stinger conical diamond elements for superior impact and wear resistance. StingBlade bits improve ROP and footage drilled while maintaining greater toolface control and minimizing shock in challenging drilling applications that can cause impact damage to conventional bits.

During field testing in over 27 countries, StingBlade bits averaged 56% increase in footage compared with offsets.

Element placement mitigates damage

In addition to the increased impact resistance enabled by Stinger elements, StingBlade bits drill with less overall torque than PDC bits, reducing reactive torque fluctuations. This allows StingBlade bits to yield higher build rates, stay on target better, and achieve directional drilling objectives in less time.

With a more balanced cutting response, StingBlade bits consistently drill with less shock and vibration, enabling longer runs at higher ROPs, prolonging the life of the bit and other BHA components. Compared with conventional PDC bits, StingBlade bits can produce 53% fewer lateral and 37% fewer axial vibrations.

The concentrated point loading of Stinger elements enables StingBlade bits to generate larger cuttings, which can be analyzed for accurate identification of mineralogy, porosity, permeability, and hydrocarbon shows at the rigsite.



StingBlade bit.

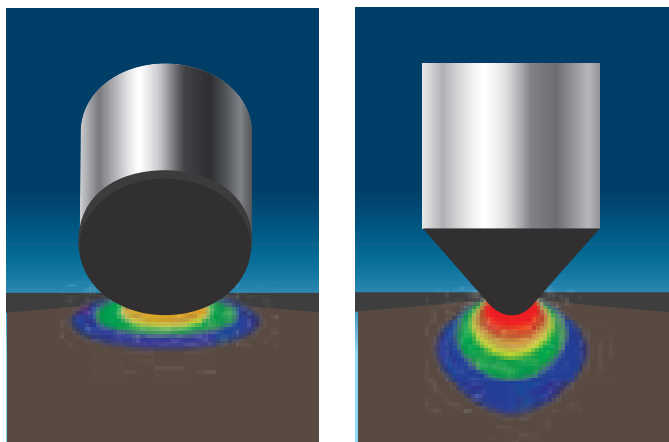

FEA modeling shows that the Stinger element (right) enacts a higher stress on the formation, fracturing high-compressive-strength rock more efficiently compared with a conventional PDC cutter (left).

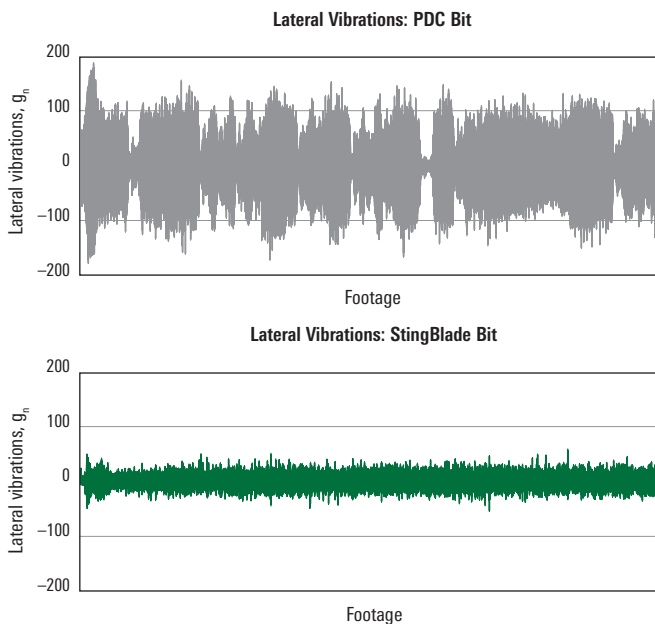

AxeBlade Bit

Rugged impact resistance and higher ROP

Unique-geometry cutting elements outlast conventional PDC cutters

AxeBlade* ridged diamond element bits utilize the newest 3D cutting element with a unique ridge-shaped geometry. These Axe* ridged diamond elements combine the shearing action of conventional PDC cutters with the crushing action of tungsten carbide inserts (TCI). This cutting method achieves at least 22% deeper penetration, removing more formation to provide higher instantaneous ROP when using the same WOB and rpm applied to conventional PDC cutters. The diamond table on the element ridge, which is 70% thicker than that of a conventional cutter, gives the Axe element increased frontal impact resistance. For operators, this means that the AxeBlade bit delivers improved durability and dull condition for maximum ROP throughout the run.

Field tests of the AxeBlade bit have demonstrated up to 29% improvement in ROP compared with similar bit designs using conventional PDC cutters, resulting in significant rig time and cost savings for operators.

The reduced cutting force required by Axe elements translates to less overall torque, reduced reactive torque fluctuation, and better toolface control in curve applications. This advantage enables better build rates and higher overall ROP, helping maximize production zone exposure and minimize NPT by delivering better trajectory and well placement.



AxeBlade bit.

Torque Comparison: Conventional PDC Cutter vs. Axe Element

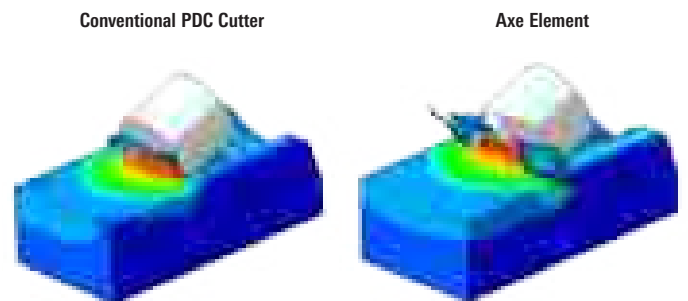
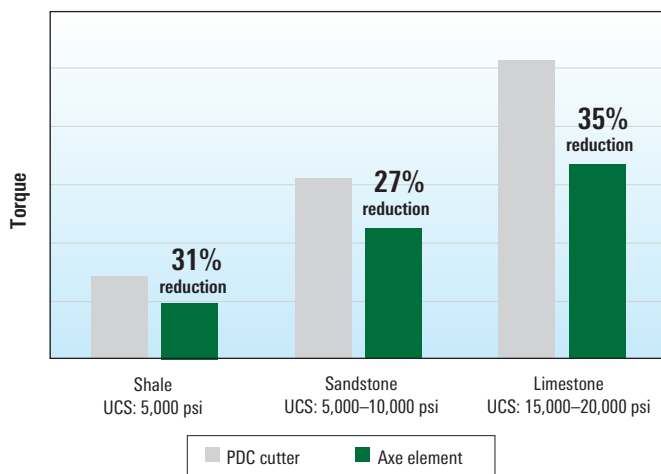

FEA testing showed that the Axe element achieves at least 22% deeper penetration compared with conventional PDC cutters under the same drilling conditions and parameters.

Results from laboratory testing show that the ridged shape of the Axe element (green) enables the AxeBlade bit to generate less torque than conventional PDC bits in a variety of formations.

Fixed Cutter Products



Fixed Cutter Bits Product Line

AxeBlade

Ridged diamond element bit



Directional PDC drill bit

Matrix or steel bits for improved directional response



StingBlade

Conical diamond element bit



SHARC* high-abrasion-resistance PDC drill bit

Matrix or steel bits for improved durability and wear resistance



Central Stinger

Conical diamond element



Spear* shale-optimized steel-body PDC drill bit

Steel-body PDC drill bits for improved performance in shales



ONYX 360 rolling PDC cutter

Cutters revolve 360° to stay sharper longer



Standard PDC drill bit

Premium performance with excellent durability



Kinetic* diamond-impregnated bit

Matrix bits for high-rotary-speed applications including positive displacement motors (PDMs) and turbodrilling



Fixed Cutter Bits

Directional PDC drill bit

Excellent steering response and improved performance

IDEAS platform analysis and field experience have shown that a single bit design can provide exceptional performance with a variety of directional drilling systems if it is dynamically stable. The earlier perception was that each type of rotary steerable system (RSS) or steerable motor BHA required its own bit design with highly specialized directional features.

Directional bits with IDEAS platform certification are stable and produce less torque and stick/slip in transitional drilling. The risk of time-consuming and costly trips due to vibration and shocks is greatly reduced.

Directional drill bit nomenclature

M D 6 1 6

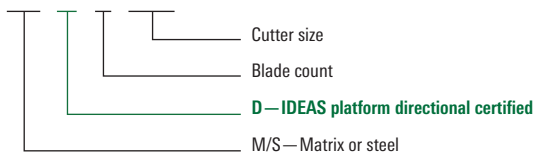

12 1/4-in MD616.

Fixed Cutter Bits

SHARC high-abrasion-resistance PDC drill bit

Bit durability and maximum ROP in abrasive formations

The cutting-structure layout of a SHARC PDC drill bit features two rows of cutters set on certain blades. Each row reinforces the other to provide maximum durability over the critical nose and shoulder areas of the bit, ensuring that ROP capability is not compromised.

Additionally, the double rows are oriented to ensure that hydraulic cleaning and cooling efficiency are maintained. This feature is important not only in abrasive interbedded sands, but also in surface intervals with high ROP or when hydraulic energy is compromised, for example, on motor runs.

When drilling hard, highly abrasive formations, SHARC PDC bits maintain maximum ROP over the target interval. Drilling faster and staying downhole longer, these bits are achieving superior performance in challenging applications all over the world.

The key to achieving both bit durability and maximum ROP is maintaining drillbit stability across a broad range of downhole conditions. SHARC bits are designed using the IDEAS platform, specifically to eliminate vibration, resulting in maximum stability for superior wear resistance. Their durability eliminates unnecessary trips, saving time and costs for the operator.

SHARC bit nomenclature

M D S 6 1 3

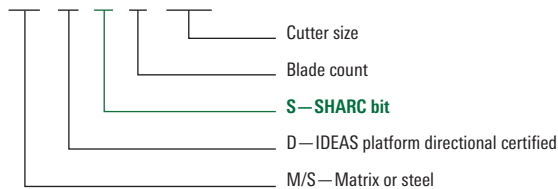

8 1/2-in MDS613.

Fixed Cutter Bits

Spear shale-optimized steel-body PDC drill bit

Proven drilling performance

Introduced in 2011, the Spear bit significantly reduces bit balling and cuttings that tend to pack around the blades of matrix-body bits.

Characterized by its distinctive bullet shape and smaller-diameter steel body, the streamlined Spear bit puts more distance between the bit body and borehole. This helps increase cuttings evacuation by minimizing blade packing and nozzle plugging, enabling the bit to drill more efficiently. After more than 5,000 runs, the Spear bit's innovative capabilities have proved to increase drilling performance and lower drilling costs of curve and long-lateral sections in unconventional shale plays.

Next-generation Spear drill bits

Based on Spear bit performances and a redesign program conducted by Smith Bits using IDEAS platform, the next-generation Spear bit has demonstrated greater directional control and ROP increases of as much as 40%.

Spear bit nomenclature

S D 6 1 3

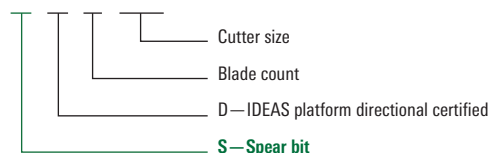

The next-generation Spear bits feature a smaller body profile that promotes the movement of cuttings around the body and into the junk slot.



SD613.

Fixed Cutter Bits

Standard PDC matrix and steel bits

Workhorse of the oil field, delivering premium performance with superior durability

Features such as cutter types, cutter layout, and blade geometry are continuously being evaluated and improved to deliver value and drive down drilling costs. Certification with IDEAS platform ensures these bits offer optimal performance.

Standard PDC bit nomenclature

M D 6 1 6

Cutter size

Blade count

D—IDEAS platform directional certified

M/S—Matrix or steel



8 3/4-in MD616.

Fixed Cutter Bits

Kinetic bit for high-speed applications

Holder of world and field records for the most footage drilled and highest ROP

Designed for superior performance when drilling at high rotary speeds through the toughest, most abrasive formations, Kinetic diamond-impregnated bits are built with precisely engineered GHIs and thermally stable polycrystalline (TSP) diamond inserts, premium PDC cutters, and proprietary diamond-impregnated matrix materials. Each element is chosen to optimize both durability and ROP.

Application-specific design

Most Kinetic bits use strategically placed premium PDC cutters in the cone area to improve drillout capability and maximize ROP, and the impregnated matrix material enhances durability. TSP diamond inserts are positioned on the gauge to ensure that the bit maintains a full-gauge hole in extremely abrasive applications. They are also placed on the bit shoulder for increased wear resistance in this critical area. Kinetic bits can be customized with different bonding materials and diamonds to match the formation being drilled and the drive system used, making the bits ideal for exploiting the higher rotational velocities possible with turbodrills.

The bit uses a combination of center-flow fluid distribution and precisely placed ports to enhance bit cooling and to ensure efficient bit cleaning. These functions are particularly important in softer formations, enabling the bit to drill mixed lithologies effectively. There is no need to trip to change the type of bit because Kinetic bits are able to drill PDC-drillable shoe tracks. They are cost effective in overbalanced applications, where drilling with a conventional fixed cutter or roller cone bit results in low ROP and reduced footage.

A hybrid design, designated with an “H” in the bit nomenclature, is a combination of a traditional PDC bit and a diamond-impregnated bit. Hybrid Kinetic drill bits are suitable in borderline-PDC-drillable formations.

GHI technology

GHIs are individual cylinders of impregnated material used in Kinetic bits. Each insert is manufactured using a proprietary granulation process that ensures a much more uniform distribution of the diamond material compared with the conventional pelletization process. The result is a more consistent GHI that is significantly more durable, maintains its shape, and drills faster for longer.

While drilling, GHIs continuously sharpen themselves by grinding away the bonding material to expose new diamonds. Because the GHIs are raised and enable a greater flow volume across the bit face, they enable Kinetic bits to drill faster in a wider range of formations.

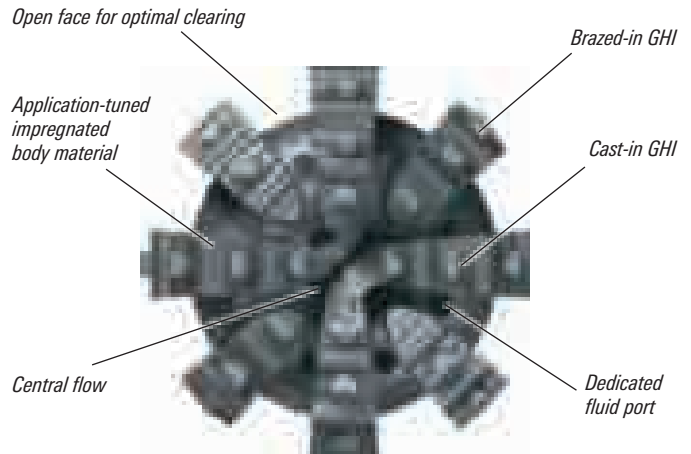

KH813.

Kinetic bit nomenclature

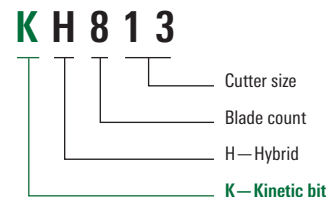

Fixed Cutter Bits

Optional features

Low-exposure managed depth of cut (MDOC)

Feature	Cutter backing raised to minimize excessive depth of cut because of formation heterogeneity
Advantage	Reduced cutter loading and minimized torque in transitional drilling
Benefit	Minimized cutter breakage to extend bit life



L

Replaceable Lo-Vibe* depth of cut control inserts

Feature	Lo-Vibe inserts that can be replaced when needed (wear, breakage, etc.)
Advantage	Limitation of excessive depth of cut and reduced torsional vibration
Benefit	Superior ROP and bit life

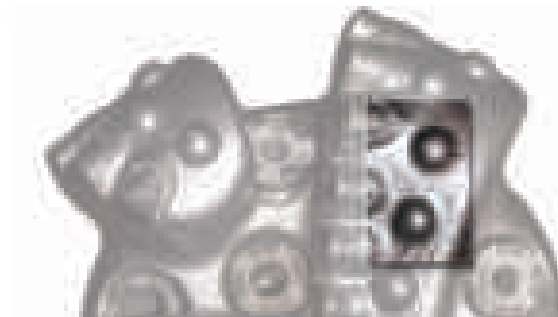

M

Lo-Vibe insert option

Feature	Lo-Vibe inserts
Advantage	Improved bit stability and reduced potential for damage to the cutting structure by restricting lateral movement and reducing the effects of axial impacts
Benefit	Optimized ROP and bit life for long drilling intervals and minimized tripping

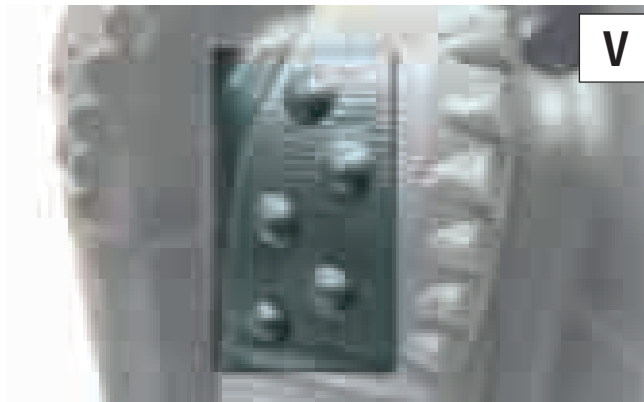

V

PowerDrive Archer* high build rate RSS gauge configuration

Feature	Specifically designed gauge characteristics
Advantage	Optimal directional performance
Benefit	Maximum dogleg severity capability and superior toolface control



G

Fixed Cutter Bits

Optional features

Z

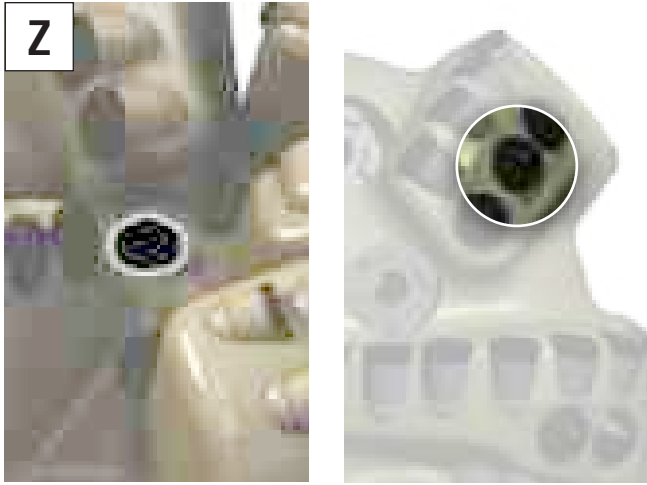

Stinger conical diamond element

- Feature More efficient rock failing
- Advantage Improved bit stability and decreased vibration
- Benefit Increased drilling efficiency for greater ROP

K



Impregnated cutter backing

- Feature Diamonds impregnated in the matrix behind the PDC cutters
- Advantage Limitation of PDC cutter wear
- Benefit Increased footage drilled in abrasive applications

H



Antiballing

- Feature More nozzles than standard
- Advantage Increased cleaning, cooling, and cuttings evacuation with available hydraulic flows; higher flow rates with minimal increase in pump pressure; and reduced risk of bit balling
- Benefit Superior ROP and bit life and longer drilling intervals

Fixed Cutter Bits

Optional features

Fewer nozzles

Feature	Fewer nozzles than standard
Advantage	Reduced nozzle count to match drilling, formation, and hydraulic system capabilities; reduced flow rate required to achieve an appropriate hydraulic horsepower per square inch (HSI); elimination of more numerous, smaller nozzles that can become plugged
Benefit	Superior ROP and bit life and longer drilling intervals

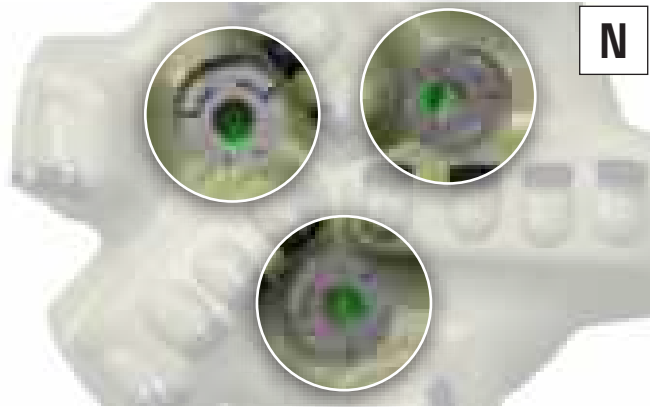

30-series nozzles

Feature	Contains 30-series nozzles
Advantage	More freedom in cutting structure design, particularly for smaller bits with limited areas for placement of larger nozzles
Benefit	High efficiency for cleaning, cooling, and cuttings evacuation without cutting structure compromises that would reduce ROP or bit life



40-series nozzles

Feature	Contains 40-series nozzles
Advantage	Increased thread size for resistance to wear and erosion
Benefit	Reduced pop-up force when tightening nozzle



50-series nozzles

Feature	Contains 50-series nozzles
Advantage	Maximum adjustable total flow area (TFA) for smaller- or heavier-set designs
Benefit	High efficiency for cleaning, cooling, and cuttings evacuation without cutting structure compromises that would reduce ROP or bit life



Fixed Cutter Bits

Optional features

Q



Fixed ports

- Feature** Incorporates fixed ports
- Advantage** Optimized hydraulics in applications where nozzles compromise bit design because of space limitations or other similar reasons; additional cleaning of the cutting structure
- Benefit** Improved ROP and bit life

E



Extended gauge length

- Feature** Longer than standard gauge
- Advantage** Enhances bit stability and allows more area for gauge protection components
- Benefit** Improves borehole quality

Fixed Cutter Bits

Optional features

Short gauge length

Feature	Short gauge length
Advantage	Improved bit steerability for directional and horizontal applications; reduced slide time and footage by achieving builds and turns more quickly
Benefit	Lower cost per foot and higher overall ROP



S

Active gauge

Feature	Active gauge
Advantage	More aggressive side cutting
Benefit	Facilitation of openhole sidetrack applications



A

Backreaming cutters

Feature	Backreaming cutters
Advantage	Strategic placement of cutters on upside of each blade to enable backreaming in tight spots; reduced potential of "bit sticking" while pulling out of the hole
Benefit	Sufficient backreaming to condition borehole without major risk of gauge pad wear



B

Fixed Cutter Bits

Optional features

PX

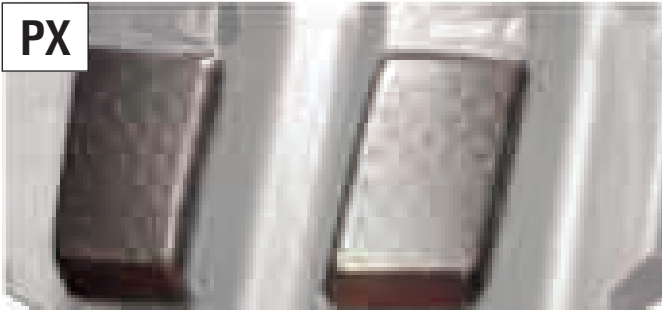

Diamond-enhanced gauge protection

- Feature Diamond-enhanced gauge protection
- Advantage Extra protection to gauge
- Benefit In-gauge borehole and improved bit life for longer drilling intervals to eliminate extra trips

T



Turbine sleeve

- Feature Turbine sleeve
- Advantage Reduced vibration and borehole spiraling in turbine applications and variation of sleeve lengths to best match a specific application
- Benefit Improved ROP and bit life for longer drilling intervals that eliminate extra trips

PXX



Full-diamond gauge pad on turbine sleeve

- Feature Full-diamond gauge pad on turbine sleeve
- Advantage Greatest possible gauge life in highly abrasive formations and underbalanced drilling
- Benefit In-gauge borehole in extreme drilling environments; longer drilling intervals eliminates tripping

Fixed Cutter Bits

Optional features

DOG* drilling on gauge sub

- Feature DOG sub
- Advantage Reduced borehole spiraling
- Benefit Enhanced BHA stability and in-gauge wellbore



D

Non-API-standard connection

- Feature Nonstandard bit connection
- Advantage Minimized length between bit box and turbine or motor pin
- Benefit Stabilization, reduced bore hole spiraling, and additional gauge protection



C

IF connection

- Feature IF connection replaces standard connection
- Advantage Bit conformity to connection type of directional tools
- Benefit More flexibility in configuring a drilling assembly



I

Fixed Cutter Bits

Nomenclature

Product Line	Prefix Description
A	ARCS* alternating radius curvature stabilization PDC drill bit
D	iDEAS platform certified directional design
G	Reamers with API connections (box down, pin up)
HOX	Heavy oil series
K	Kinetic bit
KH	Hybrid PDC and impregnated bit
PR	Pilot reamer
QD	Quad-D* dual-diameter drift and drill
R	ONYX 360 rolling PDC cutter
S	SHARC bit
ST	Sidetrack
SHO	Staged hole opener
T	Turbine
V	VertiDrill* vertical-seeking drill bit
X	AxeBlade ridged diamond element bit
Z	Stinger conical diamond element

Nomenclature identifies blade count and cutter size.
Example: M616 = 6 blades and 16-mm cutters.

PDC Material	Prefix Description
M	Matrix body
S	Steel body

Face Features	Description
F	Backup cutters
K	Impregnated cutter backing
L	Limited torque
M	Replaceable Lo-Vibe insert
P	Polished cutters
V	Lo-Vibe insert

Hydraulic Features	Description
H	Higher number of nozzles than standard
N	Lower number of nozzles than standard
Q	Fixed ports
U	50-series nozzles
W	40-series nozzles
Y	30-series nozzles

Gauge Features	Description
A	Active gauge
B	Backreaming cutters
D	DOG sub
E	Extended gauge pad length
G	PowerDrive Archer high build rate RSS approved
PX	Diamond-enhanced gauge protection (gauge feature)
PXX	Full-diamond gauge pad on turbine sleeve
S	Short gauge pad length
T	Turbine sleeve

Connection Features	Description
C	Non-API-standard connection
I	IF connection

Nomenclature example

M S 6 1 6 M H P X

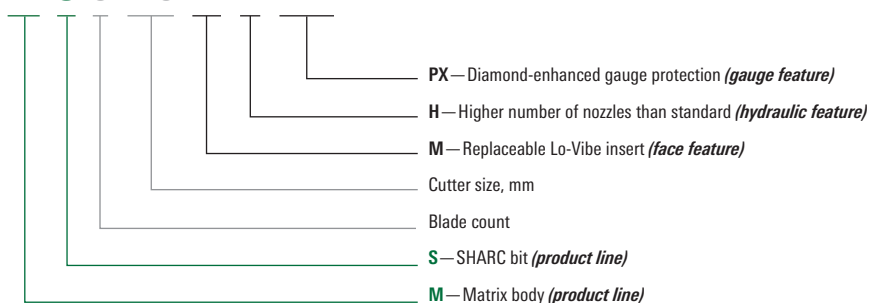

Roller Cone Bits



Roller Cone Bits

Customizable, reliable, durable TCI and milled tooth bits

Smith Bits is a leading manufacturer of an extensive range of roller cone drill bits that provide superior drilling performance. These include premium tungsten carbide insert (TCI) bits and milled tooth (MT) bits designed to withstand high temperatures and endure long run times while drilling through soft to ultrahard formations. Select from a spectrum of reliability, durability, and cutting efficiency options tailored for your specific applications.

Xplorer Premium Roller Cone Drill Bits

Performance begins with designing each Xplorer* premium roller cone drill bit using the proprietary IDEAS platform to ensure optimal drilling dynamics. Crucial to the resulting bit design are the various components that make up the bit. We engineer these individual parts and subassemblies, incorporating advanced materials and features to provide the borehole penetration you need to make your total depth in less time.

Xtra Standard Roller Cone Drill Bits

Smith Bits Xtra* standard roller cone drill bits include both TCI and MT drill bits that are continually improved for design and new materials technology. Each bit is designed using the IDEAS platform and a consistent effort that result in a wide variety of designs and premium bit performance for any application.



Xplorer Premium Roller Cone Drill Bits

Custom-designed roller cone bits to achieve your drilling objectives

Xplorer bits provide a range of options to deliver the ROP, lifetime, and dull condition you need in any depth or formation. Premium cutting structures, materials, and hydraulic options customize your application-specific bits for maximizing performance and durability in any environment.

Xplorer Premium Roller Cone Bit Technologies

Smith Bits also offers proprietary technology options that include

Xplorer Helix Configuration

Xplorer Helix* spiral TCI configuration significantly improves ROP with a proprietary spiral layout of the inserts. This configuration means the inserts deliver better bottomhole coverage, which increases rock-crushing efficiency.

Xplorer Gemini Technology

Xplorer Gemini* dynamic twin-seal technology maintains seal integrity in the harshest drilling environments and applications, lowering the risk of premature seal or bearing failure that requires an unplanned trip, and mitigating potential for cone loss.

Xplorer Kaldera Seals

Xplorer Kaldera* high-temperature seals feature elastomer and grease components that are fully optimized for high temperatures, helping to minimize premature seal or bearing failure, improve reliability, and deliver longer bit runs in challenging downhole conditions.

Xplorer Shamal Inserts

Xplorer Shamal* carbonate-optimized inserts rely on tungsten carbide to reduce heat checking and subsequent insert chipping and breakage in carbonate formations. Improved dull condition leads to longer and faster bit runs.

Xplorer Expanded bits

Xplorer Expanded* soft-formation milled tooth drill bits feature strategically placed self-sharpening milled teeth to help increase ROP over extended run lengths. Additionally, full hard-metal coverage over the entire tooth maximizes durability for improved bit life and run distance.

Xplorer TCT bits

Xplorer TCT* two-cone drill bits are designed based on extensive analysis to ensure that the cutting structure layout exploits the bit's unique characteristics. Compared with tri-cone bits, two-cone bits have higher point loading per tooth for improved formation penetration. They also benefit from current technology for enhanced insert geometries and the latest carbides and hardfacing materials.



Xplorer Bit Nomenclature



Xplorer Premium Roller Cone Drill Bits

Premium Cutting Structure

Specialized cutting structures that allow maximum mechanical energy to be applied to the formation

Xplorer Helix Spiral TCI Configuration

The Xplorer Helix configuration features a proprietary spiral layout of the TCI inserts that increase rock-crushing efficiency that improves ROP up to 70%.

Engineered to counteract tracking

Conventional bit cutting structures feature rows of teeth that create ridges of rock, causing the bit to track into the grooves or craters. The Xplorer Helix configuration is designed to counteract tracking by staggering the inserts into a spiral array. Developed using the IDEAS platform, Xplorer Helix bit requires intricate planning during manufacturing so that the staggering of inserts do not interfere with patterns on the other two cones of the bit.



Nomenclature for bits with Xplorer Helix spiral TCI configuration

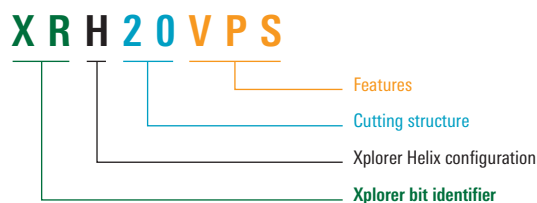

Xplorer Premium Roller Cone Drill Bits

Premium Seal Technology

Seal synergy to maximize durability and reliability

Xplorer Gemini Twin-Seal Technology

The proprietary dual-material primary seal combines a highly wear-resistant elastomer on the dynamic face and a softer energizing material that exerts a consistent contact pressure. The bullet-shaped seal has a large cross-sectional profile to provide maximum protection for the bearing.

The secondary seal is made from a mix of patented materials and is designed to prevent abrasive particles in the wellbore fluids from coming into contact with the bearing seal. A thermoplastic fabric reinforced with aramid fiber is positioned on the dynamic face, embedded in an elastomer matrix. The fabric provides resistance to wear and tear and heat damage. The elastomer matrix provides elasticity and proven sealing ability.

Although they work independently, the seals create a synergy that allows them to perform reliably for extended periods of time at higher rpm, heavier drillstring weights, extreme dogleg severity, and increased mud weights and pressures.

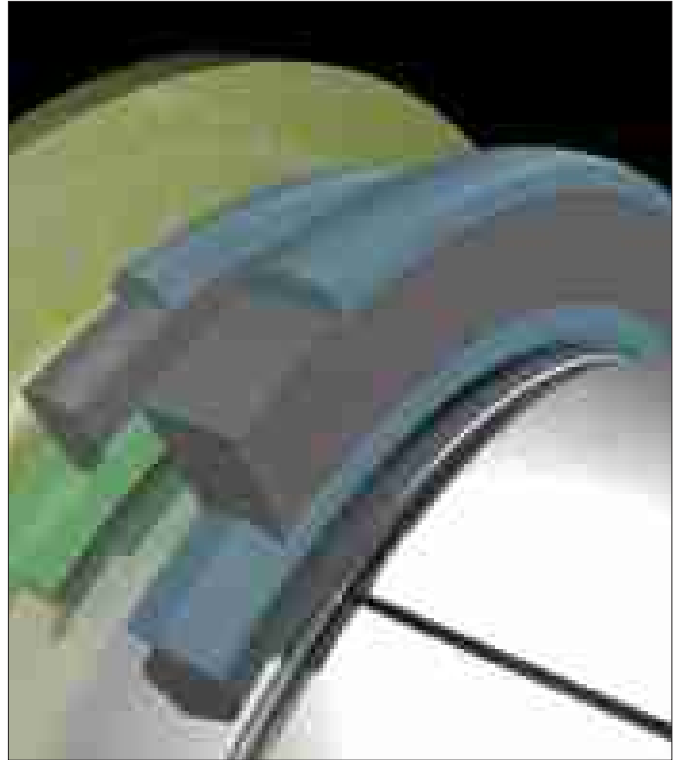

Nomenclature for bits with Xplorer Gemini twin-seal technology

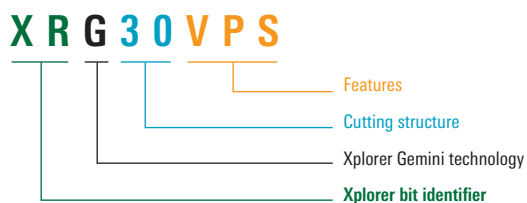

Xplorer Premium Roller Cone Drill Bits

Premium Seal Technology

Roller cone products for geothermal and high-temperature applications

Xplorer Kaldera HT Seals

Geothermal and high-temperature drill bits

High-temperature drilling environments, seen most commonly in geothermal wells, provide a unique set of challenges for downhole equipment. In many of these applications, the TCI roller cone bits used to drill these wells must endure hard and abrasive formations or steam or hot rock in basement formations where temperatures can exceed 500 degF.

At that temperature, a standard 300-degF-rated bit's elastomer seals and lubricating material quickly degrades causing bearing failure, resulting in reduced on-bottom drilling hours, multiple bit runs and trips, and increased development costs.

Drilling for unique energy calls for a unique bit

Xplorer Kaldera seals are proprietary composite elastomer seals with specialized fabric compounds and a proprietary high-temperature grease formula. These innovations increase seal life, lubricity, and load capacity at elevated temperatures for HT applications.

Proven durability in high-temperature applications

Tested against baseline bits in geothermal superheated steam applications where temperatures can reach 530 degF, the bit using Xplorer Kaldera seals was:

- On-bottom drilling time was 3% to 37% greater
- Average run length was 33% greater.

Nomenclature for bits with Xplorer Kaldera HT seals

X R K 4 7 0 D P S

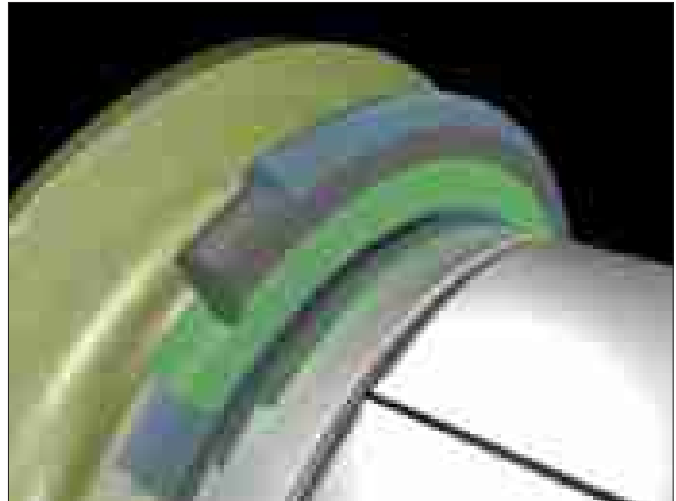
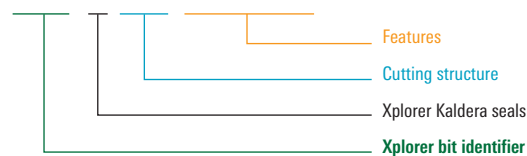

Xplorer Premium Roller Cone Drill Bits

Cutting Materials—Tungsten Carbide Insert

Hard carbonate drilling technology with tungsten carbide inserts

Xplorer Shamal Carbonate-Optimized Inserts

Xplorer Shamal inserts incorporate a range of TCI developed for maximizing bit performance in hard carbonate formations.

They use a range of proprietary coarse-carbide grades, which are designed to combat heat checking and subsequent chipping and breakage of inserts—the primary dull characteristics when drilling hard carbonates.

Incorporating unique cone layouts and insert geometries, bits using Xplorer Shamal inserts provide superior ROP and durability in challenging applications throughout the world.

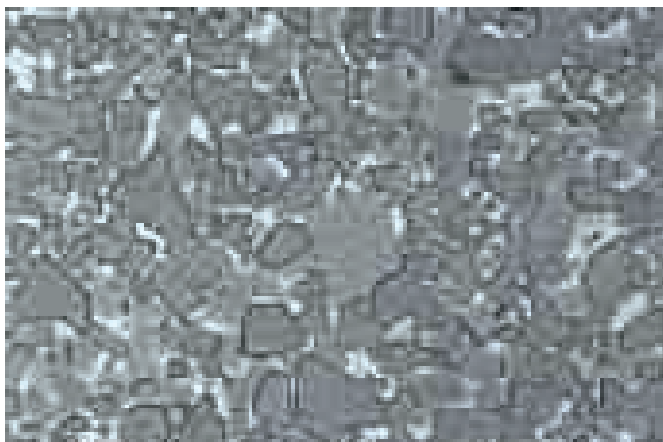

The proprietary TCI materials in Xplorer Shamal inserts maximize durability in hard carbonate formations.

Nomenclature for bits with Xplorer Shamal carbonate-optimized inserts

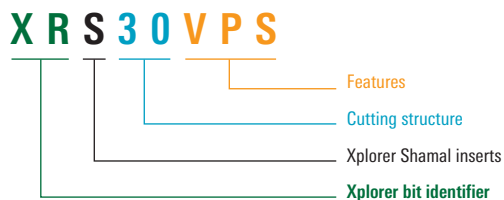

Xplorer Premium Roller Cone Drill Bits

Exclusive Smith Bits Bearing Technology

Consistent load distribution to reduce bearing fatigue

Silver Plating

Exclusive Smith Bits Technology

Solid lubricant on the bearing sleeve reduces startup and running torque, and ensures bearings run smoother, cooler, and longer for maximum performance and reliability.

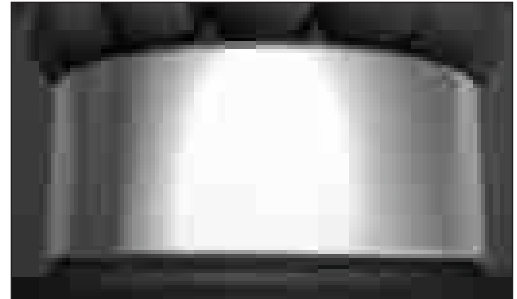

Floating Sleeves

Exclusive Smith Bits Technology

Optimized bearing sleeve reduces effective speed to minimize wear and damage for improved durability.



Xtra Standard Roller Cone Bits

Seal Technology

Advanced designs to ensure greater wear resistance in demanding applications, including high rpm and high temperature

O-Ring

Rotary O-ring seal with optimized properties delivers superior seal reliability in a range of drilling environments.

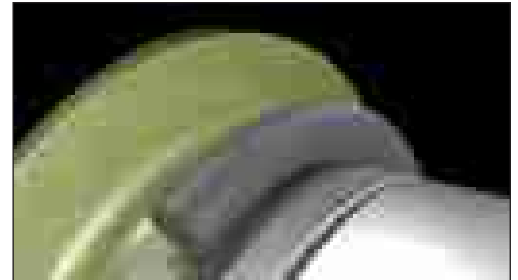

Bullet Drillbit Bearing Seal

This advanced dual-material seal design includes a highly wear-resistant dynamic face with a softer energized elastomer. The result: longer seal life in high-rpm applications.

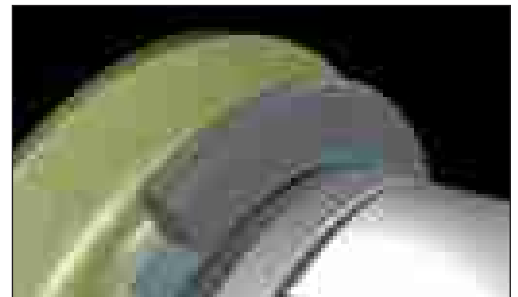

Dual Dynamic

The unique dual-dynamic seal configuration features highly wear-resistant material on the dynamic inner and static outer parts of the seal. Between these is a specialized energizing elastomer that improves high-rpm reliability through reduced wear.

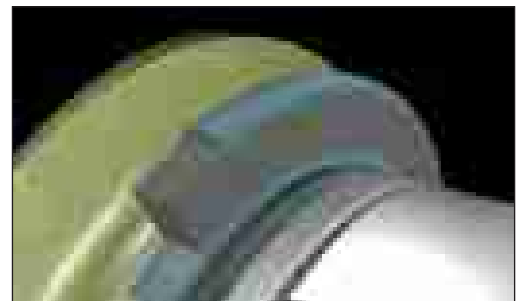

Xtra Standard Roller Cone Bits

Bearings Technology

Uniform stress distribution suitable for heavy loads at moderate to high speeds

Shape-Optimized Logarithmic Roller

This roller provides uniform load distribution across its full length, reducing bearing damage and fatigue.



Roller

Cylindrical rollers provide even loading across the full length of the roller for reduced bearing fatigue.



Xtra Standard Roller Cone Bits

Nozzles/Hydraulics

Enhanced hole cleaning configurations that reduce bit balling and BHA sticking while improving ROP

V-Flo Vectored-Flow Nozzle Configuration

Enhance fluid flow around the bit with the V-Flo* vectored-flow nozzle configuration to minimize cuttings removal and minimize the risk of bit balling, which can cause the BHA to stick downhole.



Mini Extended Nozzles

By increasing fluid energy at the bottom of the hole, this configuration increases impingement pressure and reduces the risk of bit balling for increased ROP.



Extended Vectored Nozzle Sleeve

Focused fluid energy can be custom-oriented to address bottomhole or cone cleaning. Nozzle angles are precisely positioned to direct fluid flow, increasing cleaning efficiency and maximizing ROP through higher impingement pressure.

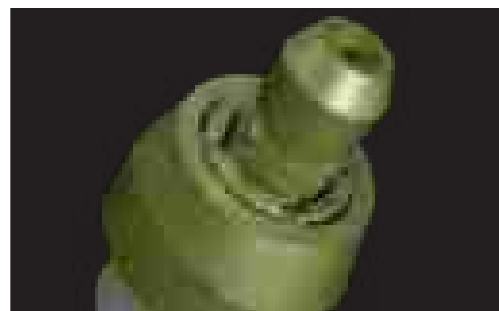

J-3 Hydraulic System

This multijet hydraulic system incorporates optimized hydraulic positioning to enhance cone cleaning and cuttings evacuation. Efficient cone cleaning and cuttings removal in larger-diameter hole sizes (greater than 16 in) is essential to eliminating bit balling and improving ROP.



Xtra Standard Roller Cone Bits

Lubrication System

Pressure equalization and high-performance grease to help maintain bearing and seal integrity under the most strenuous downhole conditions

Dome Vent Reservoir

The advanced pressure equalization system increases bearing and seal reliability under dynamic downhole pressure fluctuations and helps prevent drilling fluid contamination of the grease.



STL Grease

This synthetic grease provides a high-weight film that is extremely temperature stable and delivers optimal seal and bearing lubricity at elevated bearing loads and rpm.



Xtra Standard Roller Cone Bits

Cutting Inserts—Tungsten Carbide Insert

Robust insert geometries for exceptional performance and minimized downtime

Relieved Gauge Chisel

Enhanced gauge insert geometry improves gauge resilience to ensure subsequent BHAs or casing string can be run in hole with minimal torque, drag, or sticking issues.

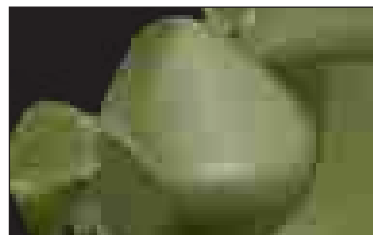

Sculptured Chisel

Shape-optimized tungsten carbide inserts incorporate reduced-stress risers to improve robustness.

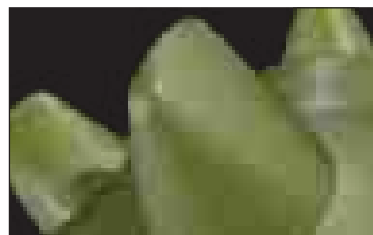

Conical

Conical-shaped inserts provide efficient drilling in a variety of applications with improved durability under high loading conditions.

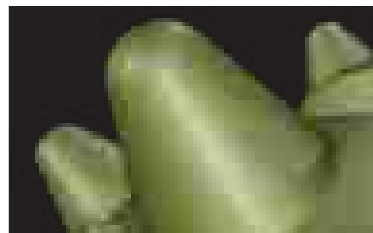

DogBone Insert

DogBone* durable and aggressive drillbit inserts feature reengineered inner-row insert-tip geometry that reduces the chances of chipping and breakage. In combination with the coarse-grained carbides in Xplorer Shamal inserts, a DogBone insert delivers improved run performance with superior dull condition.

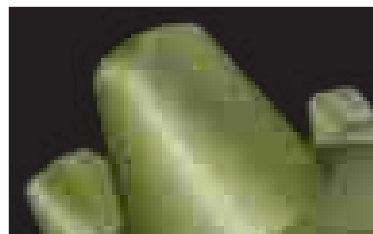

Semiround Top

Specialized insert geometry reduces gauge rounding and wear, ensuring the bit can deliver an in-gauge hole to minimize nonproductive reaming time and costs.

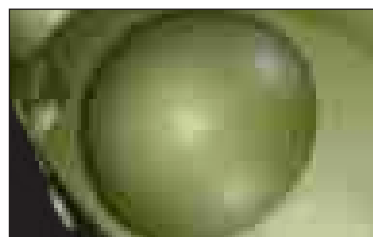

Xtra Standard Roller Cone Bits

Cutting Structure

Specialized cutting structures to apply maximum mechanical energy to the formation for optimized performance and improved durability

Cone Protection

Application-specific designs place inserts between the main rows to eliminate formation ridges to reduce cone damage and extend run length.



Binary

Strategically positioning semiround top inserts between the primary inserts improves bit durability and enables longer in-gauge bit runs. This minimizes NPT and costs and ensures subsequent BHAs or casing strings can be run in hole with minimal issues.

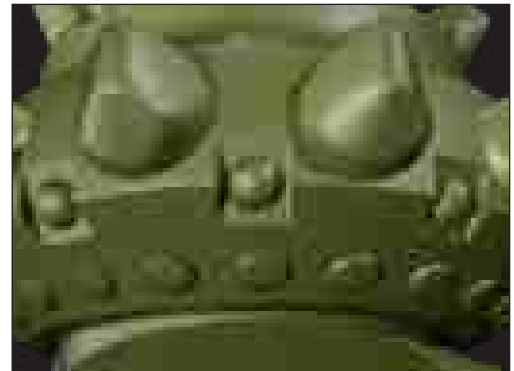

Xtra Standard Roller Cone Bits

Cutting Teeth — Milled Tooth

Hardfacing technologies to increase ROP and extend bit life over long runs

Self-Sharpening Hardfacing

Strategic hard-metal tooth placement and self-sharpening wear help to increase ROP over extended run lengths.



Full-Cap Hardfacing

Full hard-metal coverage over the entire tooth maximizes durability for improved bit life and run distance.



Xtra Standard Roller Cone Bits

Cutting Materials

Advanced cutting materials that deliver maximum toughness for the most demanding applications

Milled Tooth

MIC2 Drillbit Hardfacing Material

Developed specifically for drillbit applications, the proprietary MIC2* drillbit material provides a high level of wear resistance with increased fracture toughness for extended cutting structure life.



Tungsten Carbide Insert

Diamond-Enhanced Insert

Synthetic diamond-coated inserts with proprietary transition-layer technology increase wear resistance to enhance gauge durability for improved borehole quality, reducing reaming time and extending bearing life.



Percussion Hammers



GUIDE SLEEVE

Functions as a timing device to control air venting in lower chamber

BIT SHANK

Receives piston's striking energy and transmits it to the bit face

RETAINER SLEEVE

Retains bit head if a shank occurs

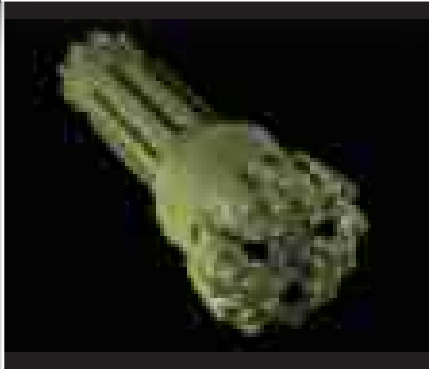
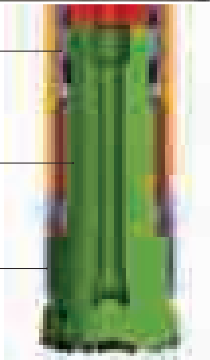

Hammers

Percussion hammers

Durability and performance for deep-hole drilling

The Impax* diamond-enhanced insert (DEI) hammer bit features a hardened-steel guide sleeve design that optimizes energy transfer between the hammer's piston and bit. The guide sleeve design also significantly improves deephole drilling reliability by eliminating the plastic blow tube, which often causes conventional hammers to fail when they are subjected to shock, vibration, abrasive wear, high temperature, erosion, and misting.

Floating feed tube

Impax bits also have an improved air delivery system that features a patented floating feed tube (US patent 7,950,475). The feed tube is designed to reduce wear and downtime issues related to wear on the piston and air delivery components.

Because high back pressure, circulation volume, and water produced from misting and influx are major causes of hammer failure, the Impax bit's lower chamber has been designed to handle 10% to 20% more water compared with conventional hammers. When water incursion forces conventional hammers to be tripped out of the well, the Impax bit's combined capabilities enable it to endure deephole drilling conditions while delivering reliable performance. Impax bits are available in 8-, 10-, and 12-in sizes.

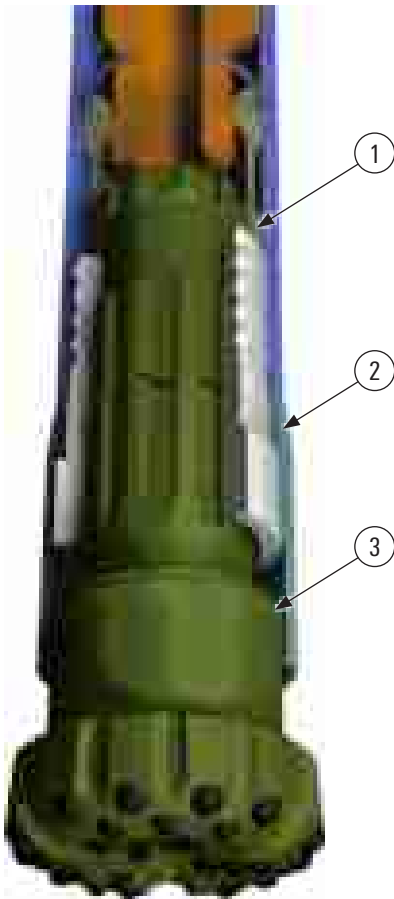

Dual retention system

Impax bits offer a highly reliable, proven retention system that helps prevent the loss of the bit head in the hole and saves the cost of fishing or sidetracking.

The system's primary retention mechanism is a set of split retainer rings at the top of the bit (1). For conventional hammer bits, the split rings are the only means of attachment to the drillstring, and the possibility of losing the bit head is so great that the bits have built-in fishing threads to facilitate retrieval.

In the Impax bits, a secondary catch system catches the bit head in the event that a shank (fracture in the spline area) prevents the primary retention rings from functioning. This is accomplished with a retainer sleeve (2) that is trapped between the shoulders of the driver sub and the hammer case. A rope thread is machined on the retainer ID and the bit OD (3), allowing ease of assembly or disassembly and the retention of the shanked head.

During the trip out of the hole, right-hand rotation of the drillstring virtually eliminates any chance that the bit head will come out of the retainer.

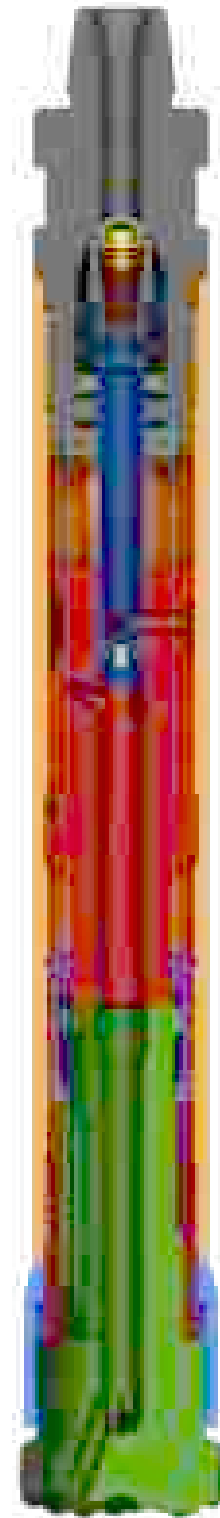

Hammer Bits

Impax diamond-enhanced insert hammer bit

Superior reliability, durability, and performance in hard formations

Adjacent-to-gauge (ATG) feature (US patent 8,387,725)

A staggered ATG row cutting structure can be positioned to augment the work capabilities of the primary gauge inserts. This differs from a standard percussion bit insert that uses a nonstaggered gauge row configuration to cut a specific but independent portion of the sidewall and hole bottom with no work overlap. The ATG row on a bit assists in cutting a portion of the outer hole, helping to reduce the load on the primary gauge row inserts. This innovative design enhances drilling efficiency by enabling the two rows to work in unison on the hole bottom rather than acting independently.

Design engineering

This configuration is designed with a precise amount of bottomhole coverage overlap between the ATG and primary gauge rows. This overlapping of insert coverage greatly enhances fracture propagation and communication because the impact points are in close proximity. Combined, the combination of ATG inserts precisely located in the cutting structure increases chip generation, improving the rock failure mechanism.

The unique bottomhole fracture pattern uses energy more efficiently and subjects the cutting structure to less stress. This increases gauge integrity compared with a conventional hammer bit. The reduced exposure to competent formation significantly improves overall bit durability while enhancing ROP potential.

Impax bit nomenclature

H 1 2 0 9 D +

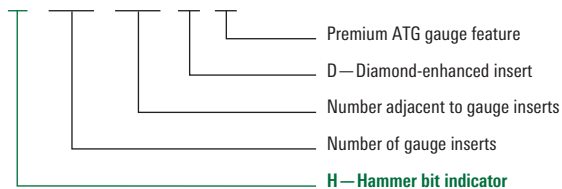

Increased footage at lower cost

Impax bits have tough and durable DEIs that increase the footage drilled and lower the cost per foot. These bits eliminate the need for reaming, extending the life of the subsequent bit and providing a quality borehole for running casing. In addition, three exhaust ports improve bit-face cleaning for longer life and better ROP.

Secondary air course

When possible, a secondary air course is used to provide additional flow channels that enhance cuttings removal by providing greater flow area across the bottom of the hole. The efficient use of circulating air improves hole cleaning capabilities and reduces the regrinding of cuttings to maximize ROP.

The bit can be supplied with a concave bottom, which optimizes directional control.



9% H1209D+ V7RPD.

Hammer Bits

Nomenclature

Impax Bit Features

Prefix	Description
C	Carbide insert
D	DEI in gauge row
F	Flat profile
G	Diamond on gauge
M	Modified profile
N	Nonretainable
PD	Optional gauge protection
R	Retainable
V	Concave profile
X	Convex profile
+	ATG structure
6	5/8-in [3/4-in, 18-mm] diameter gauge insert
7	7/8-in [22-mm] diameter gauge insert
8	1-in [25-mm] diameter gauge insert



8/8-in H1512D V6RPD

Impax Bit Nomenclature and Features

Size, in	Type	Available Features
6, 6 1/8, 6 1/4, 6 3/8, 6 1/2, 6 3/4	H0804	D, G, C, X, 6, R, PD
	H0806	D, G, C, X, 6, R, PD
	H1006	D, G, C, V, X, 6, R, PD
	H1008	D, G, C, X, 6, R, PD
7 1/8	H1209	D, G, C, V, 7, R, PD
8 3/8	H1206	D, G, C, V, 7, R, PD
	H1209	D, G, C, V, 7, R, PD
	H1209+	D, G, V, 6, R, PD
8 1/2, 8 5/8, 8 3/4, 8 7/8	H1206	D, G, C, V, 7, R, PD
	H1209	D, G, C, V, 7, R, PD
	H1509	D, G, C, V, 6, R, PD
	H1512	D, G, C, V, 6, R, PD
	H1209+	D, G, V, 6, R, PD
9 1/2, 9 5/8, 9 3/4, 9 7/8, 10 5/8, 11	H1209	D, G, C, V, 7, R, PD
	H1509	D, G, C, V, 7, R, PD
	H1209+	D, G, V, 7, R, PD
12 1/4, 12 3/8, 12 7/16	H1209	D, G, C, V, 7, R, PD
	H1509	D, G, C, V, 7, R, PD
	H1512	D, G, C, V, 7, 8, R, PD
	H1411+	D, G, V, 7, R, PD
	H1812	D, G, C, V, 7, R, PD
14 1/2, 14 3/4, 15	H1812	D, G, C, V, 7, R, PD
	H1812+	D, G, V, 7, R, PD
17 1/2	H1809	D, G, C, V, 7, R, PD

Custom sizes and types available.

Nomenclature example

H 1 5 1 2 D V 6 R P D

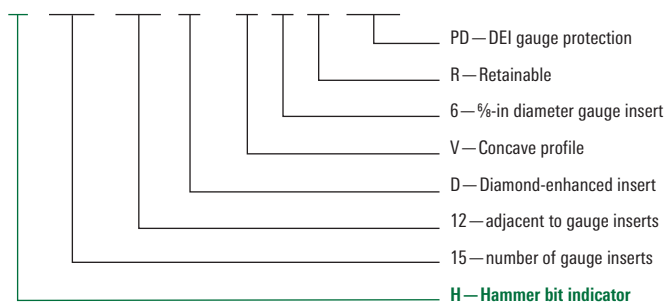

Hammer Bits

Optional features

Gauge and face inserts

Diamond-enhanced insert (DEI)

Feature	All-DEI cutting structure
Advantage	Exceptional durability and abrasion resistance
Benefit	Excellent drilling performance in longer intervals through hard formations

DEI in gauge row

Feature	Cutting structure with carbide face inserts and DEI gauge inserts
Advantage	Exceptional gauge durability and abrasion resistance
Benefit	Excellent bit gauge life when drilling shorter, medium-soft formation intervals

Carbide insert

Feature	All-carbide cutting structure
Advantage	Excellent durability and abrasion resistance
Benefit	Superior and cost-effective drilling performance in soft to medium-soft formations

Gauge insert size

5/8-in [18-mm] diameter

Feature	5/8-in-diameter DEI gauge cutting structure
Advantage	Use of heavy-set diamond gauge cutting structures
Benefit	Elimination of need to ream; increased life of subsequent bit; delivery of quality hole for running casing

7/8-in [22-mm] diameter

Feature	7/8-in-diameter DEI gauge cutting structure
Advantage	Use of diamond gauge cutting structures with improved impact resistance
Benefit	Elimination of need to ream; increased life of subsequent bit; delivery of quality hole for running casing

1-in [25-mm] diameter

Feature	1-in-diameter DEI gauge cutting structure
Advantage	Use of diamond gauge cutting structures with improved impact resistance
Benefit	Maximized insert strength for best-possible performance where durability is a requirement

Bit head retention

Nonretainable

Feature	No retaining feature on the bit head (standard fishing threads)
Advantage	Compatibility with third-party hammers that have no bit-retention features
Benefit	Flexibility to use the bit in various BHA assemblies such as those used for water wells or construction

Retainable

Feature	Patented bit head retention system
Advantage	Elimination of bit head loss in hole
Benefit	Cost savings

Gauge reinforcement

Optional gauge protection

Feature	All-diamond gauge reinforcement
Advantage	Significantly extends the life of the bit gauge
Benefit	Prevention of drilling undergauge hole; elimination of need to ream; increased life of subsequent bit; delivery of quality hole for running casing

ATG structure

Feature	Optimal placement of gauge and adjacent to gauge insert
Advantage	Maximum durability of the gauge row inserts and optimizes overall bit longevity
Benefit	Increased footage and reduced risk of hole problems where long sections and hard formations are encountered

Hammer Bits

Optional features

Bit profile shapes

Flat profile

- Feature Flat bottom with a single gauge-angle bit head profile
- Advantage Suitability for heavier-set cutting structures on the bit face
- Benefit Excellent drilling performance in hard formation intervals

Modified profile

- Feature Nonstandard bit head profile
- Advantage Unique geometry incorporated for specific operating parameters
- Benefit Enhanced performance for special drilling applications

Concave profile

- Feature Concave bottom with a dual gauge-angle bit head profile
- Advantage Additional drilling stability and directional control
- Benefit Excellent drilling performance in medium-soft to medium formation intervals where hole deviation is a primary concern

Convex profile

- Feature Flat bottom with a dual gauge-angle bit head profile
- Advantage Suitability for heavy-set face and gauge cutting structures
- Benefit Excellent drilling performance in medium to medium-hard formation intervals

Specialty Applications

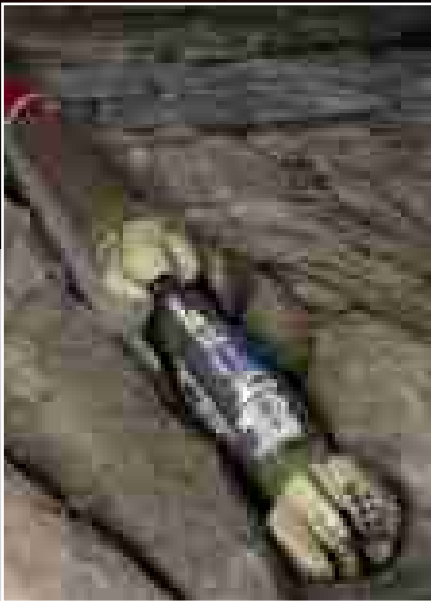

Specialty Applications

PDC hole openers

- Staged hole openers



Quad-D* dual-diameter drift and drill reamers

- Quad-D drift and drill reamer
- GeoReam* dual-diameter near-bit reamer



Direct XCD* drillable alloy casing bit



Specialty Applications

Concentric staged hole openers (SHOs)

Concentric SHOs for high work rates with minimal stick/slip and maximum concentricity

Superior borehole quality and high ROP

The SHO incorporates precision-engineered cutting structures to ensure fast, smoothly drilled, high-quality, concentric hole opening under a wide range of application conditions. SHO tools are run successfully on rotary and rotary steerable assemblies in both straight and deviated holes. While the overall cutting structure is balanced, it is divided into four sections, each serving a specific purpose.

Stage one—pilot bit

- The pilot bit, either fixed cutter or roller cone, drills the initial hole diameter. A bull nose can also be used to follow a predrilled pilot hole. SHO assemblies can be used with multiple pilot configurations for specific applications and can be positioned for various drillstring configurations.

Stage two—SHO pilot section

- The pilot section consists of one or two rows of cutting structures to recondition the pilot hole and remove any swelling clays or moving halites. Gauge pads provide initial stabilization to reduce stick/slip, whirling, or off-center tendencies as the SHO begins the staged reaming process.

Stage three—SHO pilot conditioning section

- The cutting structure is designed to minimize work rates on each cutter position for maximum durability. By stress-relieving the formation with this intermediate stage, larger-hole drilling can be done at a more aggressive ROP. The third stage recentralizes the SHO on the given well trajectory in both vertical and directional applications. Gauge pads and gauge trimmers provide the main stabilization for the SHO. Gauge pad lengths in the section may vary depending on whether the application calls for a near-bit or drillstring placement.

Stage four—SHO reaming section

- This cutting structure completes the final hole diameter. With the formation already stress relieved, the reaming section remains aggressive even in more competent formations. Gauge trimmers and spiraled gauge pads ensure good hole quality. Gauge pads in this section are kept short for directional responsiveness.

Type	Size, in	Pilot, in
SH0719	26	22
SHOS516	24	20
SHO516	24	20
SHOS616	22	19½
SHO519	17½	12¼
SHOS616	17½	12¼
SHOS519	17	12¼
SHO716	16	12¼
SHO519	16	12¼
SHO519	14¾	12¼
SHO616	14½	10⅝
SHO519	14	11
SHO516	13½	8½
SHO519	12¼	8½
SHOS616	12¼	8½
SHO516	10⅝	8½
SHO616	9⅝	8½
SHOS516	8½	6⅝
SHOS516	7½	6⅝

SHO nomenclature

S H O S 6 1 6



Specialty Applications

Quad-D dual-diameter drift and drill reamers

Maximum performance and versatility for RSS applications

The versatility of our dual-diameter reamers is best demonstrated by the applications that they drill. The GeoReam near-bit reamer is well suited to be run directly above the pilot bit for directional applications. It is also the recommended alternative to the Quad-D bit in applications for which a PDC cutting structure is not the best option.

Although compact in length, the stability-enhancing technology used in the GeoReam reamer ensures optimal hole quality while drilling. With longer pilot conditioning sections and drill string connections, Quad-D drift and drill reamers maximize performance in rotary applications. The longer pilot conditioning section acts like a string stabilizer to ensure centralization and stabilization. The Quad-D bit is designed to be run with various BHA configurations, including rotary steerable systems.

Advantages

- Directional and BHA flexibility for precise control of wellbore
- Drillout capability for eliminating trips
- Diameter control for full-gauge wellbore
- Formation-specific design for optimized drilling efficiency

Quad-D drift and drill reamer nomenclature

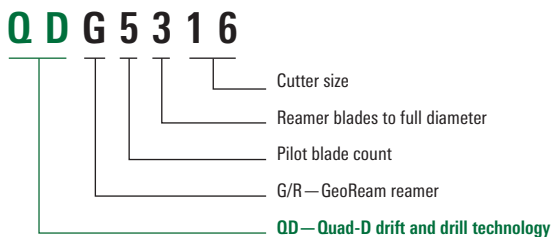

GeoReamer Near-Bit Reamer Specifications		
Type	Size, in	Pilot, in
QDGS7419	32	28
QDG5216	22	18½
QDG5216	20	16
QDG5216	20	17
QDG5216	17½	14½
QDG7313	17	13¾
QDG7313	16	13½
QDG5313	14¾	12¼
QDG5313	13½	12¼
QDG5316	13¼	12¼
QDG5216	12¼	10%
QDG5313	12¼	10%
QDG5216	9¾	8½
QDG5313	8½	7½
QDG5316	7	6
QDG5209	6½	5¾

Quad-D Bit Specifications		
Type	Size, in	Pilot, in
QDRS5216	20	16½
QDR5319	19	16½
QDRS5313	17½	14½
QDR5313	17	14½
QDR5316	16	14¾
QDR5313	14¾	12¼
QDR5213	14½	12¼
QDR5316	13¼	12¼
QDR5313	12¼	10%
QDR5313	10¾	9½
QDR5313	9¾	8½
QDRS6313	7¾	6¾

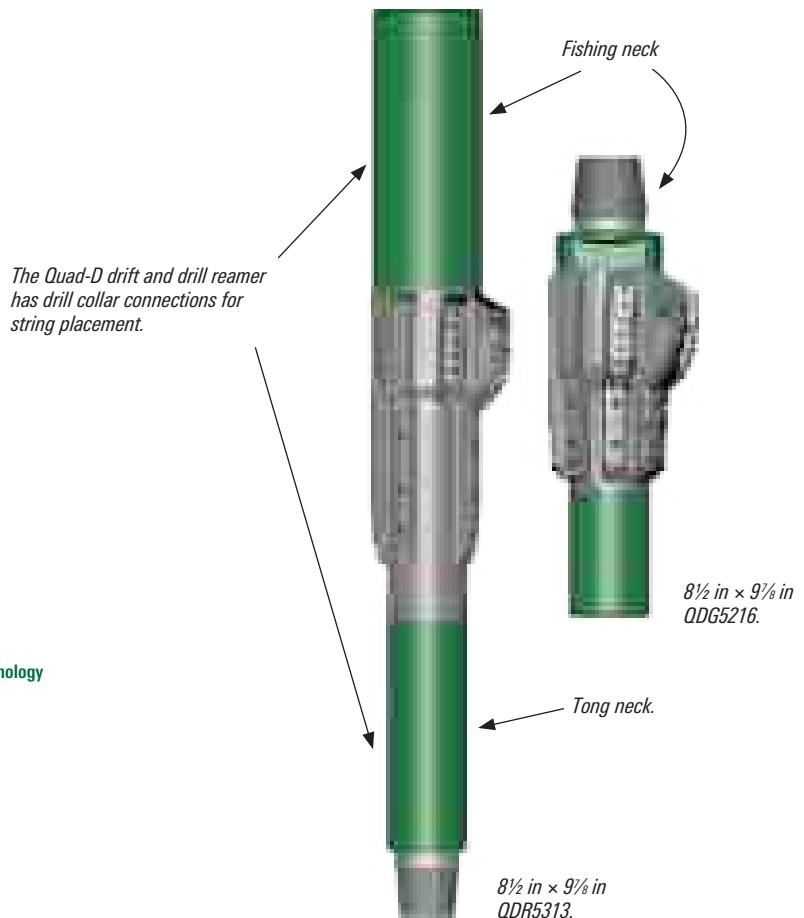

Specialty Applications

Quad-D drift and drill bicenter bits

Hole opening through installed casing or liner sections

This family of aggressive matrix- and steel-body bits is designed to provide durability, reduce torque response, maintain tangents, and reduce sliding time without compromising efficiency when drilling either float equipment or formation. It features a strong, one-piece construction and a low overall height that enhances directional capabilities when drilling with downhole motors.

Vibration is controlled by force and mass balancing, employment of spiral blades and gauge, asymmetrical blade layout, and use of Lo-Vibe inserts. Because of the resulting bit vibration control, bit rotation is maintained about the true bit axis, ensuring accurate finished hole diameter and quality. Hydraulic ports are positioned to provide efficient cuttings removal and cleaning of both the pilot and reaming sections. A unique gauge profile prevents cutters from contacting and damaging the casing and also provides a high degree of stabilization and gauge protection. Quad-D dual-diameter drift and drill bicenter bits have achieved success in a broad range of applications.

Advantages

- Drillout capability for eliminating trips
- Directional responsiveness for precise control of wellbore
- Diameter control for full-gauge wellbore
- Formation-specific design for optimized drilling efficiency

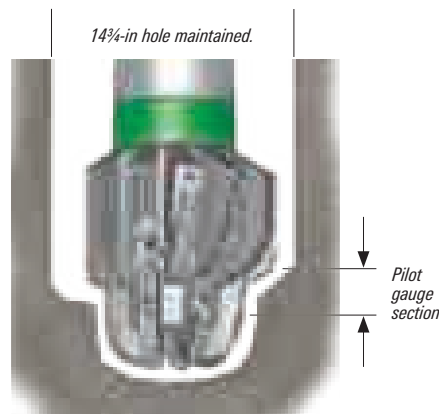

12 1/4 in x 14 3/4 in QDS7213.

Quad-D Bicenter Bit Specifications

Type	Size Availability, in
QDM3209	3 3/4 x 4 1/2
QDM3309	5 1/2 x 6 1/2
QDM4209	3 3/4 x 4 1/2
QDM4213	6 x 7
QDM7309	6 x 7
QDM7313	8 1/2 x 9 3/8, 10 5/8 x 12 1/4
QDMS4209	3 3/4 x 4 1/2
QDS3209	4 3/4 x 5 5/8, 4 1/2 x 5 3/4
QDS4209	4 3/4 x 5 5/8, 6 x 7
QDS5209	7 x 8 3/8
QDS5213	8 1/2 x 9 3/8, 12 1/4 x 14 3/4, 14 1/2 x 17 1/2
QDS5216	8 1/2 x 9 3/8, 14 1/2 x 17 1/2
QDS5219	17 x 20
QDS6309	6 1/2 x 7 1/2, 8 1/2 x 9 3/8
QDS7213	12 1/4 x 14 3/4
QDS7309	6 x 7
QDS7313	7 1/2 x 8 1/2, 8 1/2 x 9 3/8, 9 1/2 x 11, 10 5/8 x 12 1/4, 16 1/2 x 20

Quad-D drift and drill nomenclature

Q D S 7 3 1 3

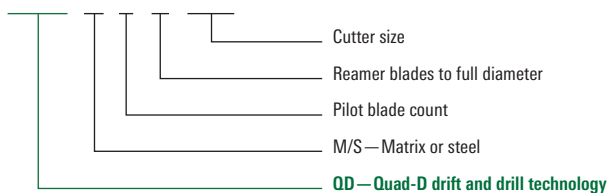

16 1/2 in x 20 in QDS7313PX.

Specialty Applications

Direct XCD drillable alloy casing bit

Drillable PDC bit for casing-while-drilling applications that drills to TD, enabling cementing casing in place and bit drillout

The nonretrievable Direct XCD drillable alloy bit is specially suited for vertical or tangential well applications. The bit drills with standard casing, which is turned at the surface by the rig's top drive.

The Direct XCD bit features a cutting structure that can be fitted with 13- to 19-mm PDC cutters, as well as unique-geometry cutting elements. The bit's sub is composed of durable oilfield-grade steel, and its body is made of an alloy that allows efficient drill out by any PDC bit after the Direct XCD bit drills to TD and casing is cemented in place. After drillout, the drillout bit can continue drilling the next interval, enabling production casing to be run below the shoe.

Direct XCD Bits Specifications

Application	Bit	Casing Size × Bit Size, in											
		7×8½	9½×11¾	9¾×12	9¾×12¼	10¾×13½	12¾×15½	13¾×16	13¾×17½	16×18¼	18¾×23	20×23	20×24
Soft formations (<8,000-psi UCS)	XCD319								•				
	XCD413					•							
	XCD416												
	XCD419				•			•		•	•	•	•
Medium formations (8,000- to 14,000-psi UCS)	XCD316						•						
	XCD416				•								
	XCD419				•			•					
	XCD516	•				•							
	XCD519									•			
	XCD616							•	•				
Hard formations (>14,000-psi UCS)	XCD516		•		•								
	XCD613				•								
	XCD716			•									

Direct XCD bit nomenclature

9⁵/₈ × 12¹/₄ XCD613

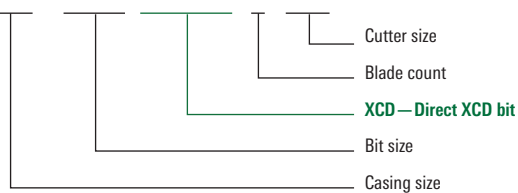

9⁵/₈-in × 12¹/₄-in XCD613.

Specialty Applications

Direct XCD drillable alloy casing bit

Exclusive PDC cutting structure

Cutting structure design comprises premium-grade PDC cutters on each blade, which can be sized from 13 to 19 mm.



Proprietary nozzles

Flow rate and hydraulic force are directed by nozzles for maximum ROP.

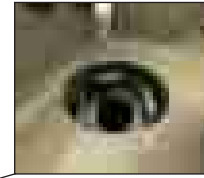

Patent-protected bit body design

Bit body composition allows drill out by any PDC bit.



Large-face waterways

Cuttings removal is maximized with large face waterways and junk slot areas.

Bimetal composition

A drillable alloy body includes a bit sub made of oilfield-grade steel.

Spiral gauge pads

Spiral gauge pads maximize bit stability and reduce vibration.

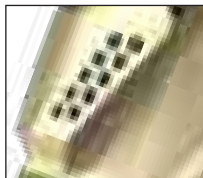

Erosion-resistant coating

An optional tungsten carbide coating applied to bit body and blades increases durability.

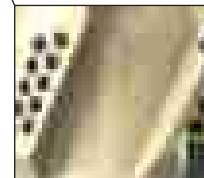

Direct XCD Bit Features

Face Features	Description
P	Premium cutters
S	Standard cutters
O	Optimized drillout path
Hydraulic Features	
H	Higher number of nozzles than standard
L	Lower number of nozzles than standard
E	Erosion-resistant nozzles
Connection Features	
B	Blank thread form
WP	Weld prep
BTC	API buttress connection
C	Premium threaded per request

Reference Guide



Reference

Total flow area chart

Total Flow Area (TFA) of Standard Nozzles, in²

Nozzle Size, in	Number of Nozzles								
	1	2	3	4	5	6	7	8	9
7/32	0.038	0.075	0.113	0.150	0.188	0.225	0.263	0.301	0.338
8/32	0.049	0.098	0.147	0.196	0.245	0.295	0.344	0.393	0.442
9/32	0.062	0.124	0.186	0.249	0.311	0.373	0.435	0.497	0.559
10/32	0.077	0.153	0.230	0.307	0.383	0.460	0.537	0.614	0.690
11/32	0.093	0.186	0.278	0.371	0.464	0.557	0.650	0.742	0.835
12/32	0.110	0.221	0.331	0.442	0.552	0.663	0.773	0.884	0.994
13/32	0.130	0.259	0.389	0.518	0.648	0.778	0.907	1.037	1.167
14/32	0.150	0.301	0.451	0.601	0.752	0.902	1.052	1.203	1.353
15/32	0.173	0.345	0.518	0.690	0.863	1.035	1.208	1.381	1.553
16/32	0.196	0.393	0.589	0.785	0.982	1.178	1.374	1.571	1.767
17/32	0.222	0.443	0.665	0.887	1.108	1.330	1.552	1.773	1.995
18/32	0.249	0.497	0.746	0.994	1.243	1.491	1.740	1.988	2.237
19/32	0.277	0.554	0.831	1.108	1.384	1.661	1.938	2.215	2.492
20/32	0.307	0.614	0.920	1.227	1.534	1.841	2.148	2.454	2.761
21/32	0.338	0.676	1.015	1.353	1.691	2.029	2.368	2.706	3.044
22/32	0.371	0.742	1.114	1.485	1.856	2.227	2.599	2.970	3.341
23/32	0.406	0.811	1.217	1.623	2.029	2.434	2.840	3.246	3.652
24/32	0.442	0.884	1.325	1.767	2.209	2.651	3.093	3.534	3.976
25/32	0.479	0.959	1.438	1.917	2.397	2.876	3.356	3.835	
26/32	0.518	1.037	1.555	2.074	2.592	3.111	3.629		
27/32	0.559	1.118	1.677	2.237	2.796	3.355	3.914		
28/32	0.601	1.203	1.804	2.405	3.007	3.608			
29/32	0.645	1.290	1.935	2.580	3.225	3.870			
30/32	0.690	1.381	2.071	2.761	3.451				
31/32	0.737	1.474	2.211	2.948	3.685				
32/32	0.785	1.571	2.356	3.142	3.927				

Reference

Recommended fixed cutter bit makeup torque

Recommended Makeup Torque—Diamond and Fixed Cutter Drill Bits with Pin Connections

API Reg Connection Size, in [cm]	Bit Sub OD, in	Minimum, ft.lbf [N.m]	Normal, ft.lbf [N.m]	Maximum, ft.lbf [N.m]
2½ [6.03]	3	1,970 [2,670.96]	2,280 [3,091.26]	2,450 [3,321.75]
	3⅝	2,660 [3,606.48]	3,100 [4,203.04]	3,300 [4,474.2]
	3¾	3,400 [4,609.78]	3,950 [5,355.48]	4,200 [5,694.44]
2⅞ [7.30]	3½	3,380 [4,582.67]	3,950 [5,355.48]	4,200 [5,694.44]
	3¾ and larger	5,080 [6,887.56]	5,900 [7,999.33]	6,300 [8,547.65]
3½ [8.89]	4⅝	5,700 [7,728.16]	6,600 [8,948.40]	7,000 [9,490.73]
	4¾	6,940 [9,409.38]	8,050 [10,914.33]	8,550 [11,592.24]
	4½ and larger	8,400 [11,388.87]	9,850 [13,354.81]	10,500 [14,236.09]
4½ [11.43]	5½	13,700 [18,574.71]	16,600 [22,506.58]	17,000 [23,048.91]
	5¾	18,100 [24,540.31]	21,100 [28,607.76]	22,400 [30,370.32]
	6 and larger	18,550 [25,150.42]	21,600 [29,285.67]	22,900 [31,048.23]
6⅝ [16.83]	7½	40,670 [55,141.12]	47,300 [64,130.19]	50,200 [68,062.06]
	7¾ and larger	41,050 [55,656.33]	47,800 [64,808.1]	50,750 [68,807.76]
7⅞ [19.37]	8½	53,100 [71,993.94]	61,850 [83,847.34]	65,670 [89,036.57]
	8¾	63,500 [86,094.44]	73,750 [99,991.58]	78,300 [106,160.5]
	9 and larger	68,600 [93,009.11]	79,800 [108,194.3]	84,750 [114,905.6]
8⅞ [21.91]	10	96,170 [130,389.01]	102,600 [139,106.9]	108,950 [147,716.4]
	10¼ and larger	107,580 [145,858.9]	114,700 [155,512.3]	121,800 [165,138.6]

Notes:

1. Recommended makeup torque dictated by all BHA components
2. Higher makeup torque values within the above ranges are recommended when high **WOB** is used.
3. Box connection bits should use makeup torque values between **Minimum and Normal**.
4. All connections must be lubricated with a joint compound meeting **API** requirements.

Recommended roller cone bit makeup torque

API Pin Size, in [mm]	Recommended Torque, ft.lbf [N.m] [†]
2½ Reg [60]	3,000–3,500 [4,100–4,700]
2⅞ Reg [73]	4,500–5,500 [6,100–7,500]
3½ Reg [89]	7,000–9,000 [9,500–12,200]
4½ Reg [114]	12,000–16,000 [16,300–21,700]
6⅝ Reg [168]	28,000–32,000 [38,000–43,400]
7⅞ Reg [194]	34,000–40,000 [46,100–54,200]
8⅞ Reg [219]	40,000–60,000 [54,200–81,300]

[†]Maximum recommended makeup torque may be higher for specifically developed roller cone bit products.

API gauge tolerances for fixed cutter and roller cone bits

Bit size, in	Fixed Cutter, in	Roller Cone, in
6¼ and smaller	-0.015 to +0.00	-0.0 to +½ ₃₂
6 ²⁵ / ₃₂ -9	-0.020 to +0.00	-0.0 to +½ ₃₂
9 ¹ / ₃₂ -13 ³ / ₄	-0.030 to +0.00	-0.0 to +½ ₃₂
13 ²⁵ / ₃₂ -17½	-0.045 to +0.00	-0.0 to +¼ ₁₆
17 ¹⁷ / ₃₂ and larger	-0.063 to +0.00	-0.0 to +¾ ₃₂

Note: Some of the above bit sizes are available on special order with alternate pin connections.

Reference

Field operating procedures for fixed cutter and roller cone drill bits

Bit preparation

Bit handling at rig site

- Care should be taken when handling or removing any bit containing diamond-cutting elements.
- Do not drop the bit even if it is in the container.
- Use a piece of wood or rubber under the bit face.

Bit inspection

- Inspect bit for integrity (cutting elements, pin connection, and makeup shoulder).
- Ensure that there are no foreign objects or obstructions in the internal fluid passageways.
- Verify TFA on bits with fixed TFA.
- Record bit size, type, and serial number.

Nozzle installation

- Ensure that nozzle series are correct for bit type.
- Gauge the orifice size of every nozzle to ensure proper TFA.
- Remove the plastic plug and ensure that O-rings are properly installed and seated.
- If different size nozzles are to be used ensure that the correct sized nozzles are in the correct place. Put bigger size nozzles in the center of the bit.
- Ensure that the threads are clean and greased (any petroleum-based grease). Fixed cutter bits with matrix threads should not be greased.
- Grease the nozzle body below the threads to prevent O-ring damage.
- Screw the nozzle in by hand until snug.
- Use nozzle wrench for final tightening. Excessive force is not necessary and can damage the carbide nozzle.
- If nozzle sizes below $\frac{9}{32}$ in are to be used, the use of drillpipe screens, a float, or both is recommended to prevent reverse circulation plugging. Use grasshoppers if necessary.

Makeup

- Ensure that the appropriate bit breaker is with the bit. Inspect to ensure good condition and fit.
- Remove the bit from the box and place face down on a piece of wood or rubber.
- Engage the bit breaker with the bit and move them onto the rotary table.
- A float above the bit should be installed, especially on extended-nozzle roller cone bits, in areas that tend to plug.
- Engage the hanging box connection to the doped threads of the bit pin.

- Proper makeup for small-diameter bits is to make up by hand for several turns, then place in the bit breaker and make up to the recommended torque.
- Uncover the rotary and locate the bit and breaker onto the breaker holder.
- Make up using the recommended torque.
- Makeup torque specifications are from API RP 7G.

Roller cone bits

- Keep BHA as vertical as possible when making up bit to ensure no damaging contact between the nozzles (full extended or minis) and the bit breaker occurs.

Tripping in the hole

- Identify potential problem areas before tripping. Trip slowly through BOP, doglegs, tight spots, ledges, casing shoes, cementing equipment, etc. Wash and ream as necessary. Severe problems may require a special cleanup run.
- Roller cone bit legs will yield slightly, and the bit can be rotated slightly to pass through some tight spots. Fixed cutter bits do not yield. Bits with PDC cutting elements are more susceptible than roller cone bits to damage during tripping, as well as vulnerable to impact damage.
- Certain types of fixed cutter bits with low junk slot area can create higher surge and swab pressures compared with roller cone bits due to more restrictive annular space.
- Local knowledge and practice will typically dictate washdown and reaming procedures. Minimum recommendation is to wash down at least the last joint to bottom at reaming speed with full circulation. Preference is to ream the last stand, or 90 ft, at reaming speed with full circulation.

Reference

Field operating procedures for fixed cutter and roller cone drill bits

Tagging bottom

- Approach the hole bottom cautiously, monitoring WOB and torque. An increase in WOB or torque will indicate contact with either the hole bottom or fill. Fixed cutter bits will typically show an increase in torque first. The bit is on bottom when torque increases with WOB. Difference between measured depth and contact point should be depth of fill.
- If fill is present, pick up above the fill and rotate to bottom with full circulation until bottomhole contact is assured. Regardless if fill is present, the pipe should always be reciprocated off bottom.
- On rotary assemblies, use a maximum of 500 lbf per inch of bit diameter, 40 to 60 rpm.
- On motor assemblies, use a maximum of 500 lbf per inch of bit diameter and the minimum allowable rpm.
- Do not use high WOB when in fill. This could cause the bit to ball.
- Circulate and rotate off bottom as close as possible (preferably less than 6 in and no more than 1 ft) and long enough (application dependent) to ensure the hole bottom is clear of fill or junk.

Drilling cement plugs, float equipment, and casing shoes

- When using fixed cutter bits to drill out, ensure that all cementing equipment (plugs, float collars, and shoes) is PDC drillable (not metallic, rubber, nylon, plastic, or cement).
- Nonrotating plugs are recommended. Alternatively, it is preferable when cementing to pump some cement on top of the plug to help prevent it from rotating during drill out.
- Using the maximum allowable flow rate to assist cleaning is preferred but may not be possible with motor assemblies.

Procedure

- Frequently raising and lowering the bit while continuing circulation and rotation will help keep the bit clear of debris. Flushing after every 1 to 2 in drilled while reciprocating 3 to 4 ft will ensure debris is removed and new material is being drilled. Should the penetration rate decrease suddenly, repeat this step until it resumes.
- Do not spud. Spudding (impacting on the hole bottom) can damage cutting structure elements on both fixed cutter and roller cone bits. It can also damage the roller cone bearing and seal system.
- Monitor pump pressure to ensure that nozzles do not become plugged.
- Change rpm if bouncing or erratic torque is encountered.

Fixed cutter bits

- On rotary, use the maximum flow rate with less than 6,000-lbf WOB and 60–100 rpm.
- On motor assemblies, drill with less than 6,000-lbf WOB and the minimum allowable rotary rpm. Local practice will dictate flow rate because a compromise is required between adequate cleaning and minimum rpm.
- Maintain low and consistent torque.

Roller cone bits

- On rotary, drill with 2,000 to 3,000 lbf per inch of bit diameter and 40–60 rpm.
- On motor assemblies, drill with 2,000 to 3,000 lbf per inch of bit diameter and the minimum allowable rotary rpm. Local practice will dictate flow rate as a compromise is needed between providing adequate cleaning and minimum rpm.
- Bouncing or erratic torque may indicate locked cones. Temporarily increase the weight to ensure cone rotation, then reciprocate the bit slightly off bottom while continuing circulation and rotation to help clean the bit. Resume with original parameters when the bouncing or erratic torque has been eliminated.
- Maintain minimum WOB and torque to prevent wiper plugs from rotating. Erratic torque may indicate a rotating plug.

Rotating plugs

- Should a plug begin to rotate, set down on plug with no rpm.
- Increase WOB until 2,000 to 3,000 lbf per inch of bit diameter is reached or until an increase of 300 psi over the normal standpipe pressure occurs.
- Begin rotation, ending with 40 to 60 rpm.
- Repeat until penetration is achieved and wiper plug is drilled.

Alternative procedure (last resort)

- Rotate bit at 20–40 rpm.
- Use 500 lbf per inch of bit diameter.
- Alternate using no flow rate for 1 min to full flow for 30 seconds.

Establishment of bottomhole pattern

Bottomhole pattern break-in is considered to be when a new bit achieves uniform cutting structure loading. Proper break-in is critical to durability and ROP.

- After drilling out the casing shoe, establish the bottomhole pattern. There may be some BHA-dictated WOB and rpm guidelines until the BHA is below the casing shoe. Optimization of WOB and rpm may have to wait until all or some of the BHA has cleared the casing shoe.

Reference

Field operating procedures for fixed cutter and roller cone drill bits

- Use extra care establishing a new bottomhole pattern when following a bit with a substantially different bottomhole profile, (e.g., a PDC bit following a roller cone bit or vice-versa).
- Roller cone bits typically drill a larger-size hole than a fixed cutter bit. Properly establish the bottomhole pattern when following a roller cone bit to ensure stability.
- Establishment of bottomhole pattern can be dependent upon factors such as bit design and BHA.

Roller cone bits

- Break-in is done with light WOB and slow rpm, and a new bottomhole pattern is normally achieved within 3 to 6 in (assuming no tracking or off-center rotation).
- On rotary, use a maximum of 500 lbf per inch of bit diameter with 40–60 rpm. On motor assemblies, use a maximum of 500 lbf per inch of bit diameter and the minimum allowable rpm—keep rotary rpm to a minimum 20–30 rpm. Minimum allowable motor rpm can be formation dependent.
- Soft, balling formations should be entered with full flow rate. At that point, WOB and rpm can be gradually increased to typical operating levels or to initial drill-off test levels. Increase WOB first, then rpm.

Fixed cutter bits

- Although a new bottomhole pattern is created in less than a bit diameter, it is preferred to drill 3–5 ft before increasing WOB and rpm.
- For starting parameters, use maximum flow rate, less than 6,000-lbf WOB, and 60 to 100 rpm.
- Maintain low and consistent torque, changing operating parameters as needed.
- Take extreme care after a coring operation or using bits of different types or profiles. A different existing profile can overload specific cutting elements, potentially causing a premature failure.

Running the bit

Controlled drilling

- If in or encountering a known hard or abrasive formation of short length with a dull bit, controlled drilling (sacrificing ROP) through the interval may enhance the subsequent bit's performance. The dull condition and bit type will determine the feasibility. Monitor the ROP and torque and follow the recommendations for evaluating ROP and torque as listed below. Proceed only if ROP and increased risk are acceptable to the customer.

Deviation and directional control

- Deviation concerns may override optimal WOB. Typically, minimum WOB is used to control deviation on rotary assemblies.

- Monitor deviation on straight holes. Reduce WOB to maximum allowable to maintain deviation specified by customer. Monitor for vibration. Generally, increase rpm to improve ROP.
- Higher torque and higher speed change bit walk direction by making the bit attack the formation at different angle due to higher torque. The bit tries to climb the hole wall at a different position at different torque levels. High speed on turbines can make the bit change direction completely.

Formation changes

- Formation changes can instigate both torsional and lateral vibrations. Monitor and adjust accordingly.
- When anticipating a harder or more difficult formation, to prevent impact damage, reduce the rpm, maintaining WOB while still in the softer formation to help prevent initiation of lateral or torsional vibrations when the hard formation is encountered. After encountering the formation, adjust the parameters or perform a drilloff test.
- If an unknown formation (anomaly or transition) is expected, reduce the rpm and the WOB to a minimum accepted level. Establish ROP and torque baselines at these levels. Monitor ROP and torque to determine when formation has been encountered and passed.

Operational parameter guidelines

- Optimal WOB and rpm determined are for a particular application and can only be continuously used in a homogeneous formation. Therefore, in intervals of various formations, ROP optimization tests will not produce the optimal weight and rotary combination.
- Drilloff tests will be necessary anytime the formation changes. Typically a range of WOB and rpm combinations is derived for the interval (e.g., interbedded formations).

Pulling the bit

- When economics dictates
- When ROP dictates
- Loss of directional characteristics
- Loss of pump pressure due to a washout

Roller cone bit

- When a substantial increase or dramatic fluctuation in torque is seen with low or high WOB and low ROP or when tagging bottom. Magnitude is typically area and application dependent.
- There is no 100% effective or reliable indicator.
- The best indicator is dramatic fluctuations of torque when tagging bottom.

Reference

Measurement units and drilling formulas

Standard Measurement Units

Quantity or Property	Units	Multiply By	To Obtain	Symbol
Depth	ft	0.3048	meters	m
Weight on bit (WOB)	lbf	0.445	decanewtons	daN
		4.535×10^{-4}	tonnes	tonne
Nozzle size	1/32 in	0.794	millimeters	mm
Drill rate	ft/h	0.3048	meters/hour	m/h
Volume	bbl	0.1590	cubic meters	m ³
		3.785×10^{-3}	cubic meters/stroke	m ³ /stroke
Pump output and flow rate	galUS/min	3.875×10^{-3}	cubic meters/minute	m ³ /min
		0.159873	cubic meters/stroke	m ³ /stroke
		0.1590	cubic meters/minute	m ³ /min
Annular velocity and slip velocity	ft/min	0.3048	meters/minute	m/min
Linear length and diameter	in	25.4	millimeters	mm
Pressure	psi	6.895	kilopascals	kPa
		0.006895	megapascals	MPa
		0.06895	bars	bar
Mud density	lbm/galUS	119.83	kilograms/cubic meter	kg/m ³
Mud gradient	psi/ft	22.621	kilopascals/meter	kPa/m
Funnel viscosity	s/qt (US)	1.057	seconds/liters	s/L
Apparent and plastic viscosity yield point	centipoise	1	millipascal seconds	mPa.s
Gel strength and stress	lbf/100 ft ²	0.4788 (0.5 for field use)	pascals	Pa
Cake thickness	1/32 in	0.794	millimeters	mm
Filter loss	mm or cm ³	1	cubic centimeters	cm ³
Torque	ft.lbf	1.3358	newton meters	N.m

Drilling formulas

Cost per foot (CPF)

$$CPF = \frac{\text{Bit cost} + \text{Rig cost (Trip time + Drilling time)}}{\text{Footage drilled}}$$

Pressure drop (ΔD)

$$\Delta P = \frac{\text{Flow rate}^2 \times \text{Mud weight}}{10,856 \times \text{TFA}^2}$$

Hydraulic horsepower (HHP)

$$HHP = \frac{(\text{Bit pressure drop}) (\text{Flow rate})}{1,714}$$

Hole area (A_h)

$$A_h = \frac{\pi \times \text{Hole diameter}^2}{4}$$

Hydraulic HP per square inch (HSI)

$$HSI = \frac{\text{Hydraulic horsepower}}{\text{Hole area, in}^2}$$

$$\text{Flow rate (Q)} = (\text{Pump strokes} \times \text{Output/stroke})$$

$$\text{Bit pressure drop } (\Delta P_{\text{bit}}) = (\text{MWt} \times Q^2) / (10,856 \times \text{TFA}^2)$$

$$\text{Hydraulic horsepower (HHP}_{\text{bit}}) = (\Delta P_{\text{bit}} \times Q) / (1,714)$$

$$\text{HSI} = (\text{HHP}_{\text{bit}}) / (0.7854 \times D^2)$$

$$\text{Jet velocity (JV)} = (0.32086 \times Q) / (\text{TFA})$$

$$\text{Impact force (IF)} = (\text{JV}) \times (\text{MWt}) \times (Q) \times (0.000516)$$

(MWt = mud weight; TFA = nozzle flow area; D = bit diameter.)

Reference

Drill collar specifications

Drill Collar Weight (Steel), lbm/ft

Drill Collar OD, in	Drill Collar ID, in												
	1	1¼	1½	1¾	2	2¼	2½	2¾	3	3¼	3½	3¾	4
2⅞	19	18	16										
3	21	20	18										
3⅞	22	22	20										
3¼	26	24	22										
3½	30	29	27										
3¾	35	33	32										
4	40	39	37	35	32	29							
4⅞	43	41	39	37	35	32							
4¼	46	44	42	40	38	35							
4½	51	50	48	46	43	41							
4¾			54	52	50	47	44						
5			61	59	56	53	50						
5¼			68	65	63	60	57						
5½			75	73	70	67	64	60					
5¾			82	80	78	75	72	67	64	60			
6			90	88	85	83	79	75	72	68			
6¼			98	96	94	91	88	83	80	76	72		
6½			107	105	102	99	96	91	89	85	80		
6¾			116	114	111	108	105	100	98	93	89		
7			125	123	120	117	114	110	107	103	98	93	84
7¼			134	132	130	127	124	119	116	112	108	103	93
7½			144	142	139	137	133	129	126	122	117	113	102
7¾			154	152	150	147	144	139	136	132	128	113	112
8			165	163	160	157	154	150	147	143	138	133	122
8¼			176	174	171	168	165	160	158	154	149	144	133
8½			187	185	182	179	176	172	169	165	160	155	150
9			210	208	206	203	200	195	192	188	184	179	174
9½			234	232	230	227	224	220	216	212	209	206	198
9¾			248	245	243	240	237	232	229	225	221	216	211
10			261	259	257	254	251	246	243	239	235	230	225
11			317	315	313	310	307	302	299	295	291	286	281
12			379	377	374	371	368	364	361	357	352	347	342

Reference

Conversion factors

Fraction to Decimal

1/64	0.0156	17/64	0.2656	33/64	0.5156	49/64	0.7656
1/32	0.0312	9/32	0.2812	17/32	0.5312	25/32	0.7812
3/64	0.0468	19/64	0.2968	35/64	0.5468	51/64	0.7968
1/16	0.0625	5/16	0.3125	9/16	0.5625	13/16	0.8125
1/8	0.0781	21/64	0.3281	37/64	0.5781	53/64	0.8281
3/32	0.0937	11/32	0.3437	19/32	0.5937	27/32	0.8437
7/64	0.1093	23/64	0.3593	39/64	0.6093	55/64	0.8593
1/8	0.1250	3/8	0.3750	5/8	0.6250	7/8	0.8750
9/64	0.1406	25/64	0.3906	41/64	0.6406	57/64	0.8906
5/32	0.1562	13/32	0.4062	21/32	0.6562	29/32	0.9062
11/64	0.1718	27/64	0.4218	43/64	0.6718	59/64	0.9218
3/16	0.1875	7/16	0.4375	11/16	0.6875	15/16	0.9375
13/64	0.2031	29/64	0.4531	45/64	0.7031	61/64	0.9531
7/32	0.2187	15/32	0.4687	23/32	0.7187	31/32	0.9687
15/64	0.2343	31/64	0.4843	47/64	0.7343	63/64	0.9843
1/4	0.2500	1/2	0.5000	3/4	0.7500	1	1.0000

English and Metric

Multiply	By	To Obtain
Acres	43,560	Square feet
Acres	0.001562	Square miles
Acres	4,840	Square yards
Barrels, water	31.5	Gallons
Barrels, water	263	Pounds
Barrels, oil (API)	42	Gallons
Barrels per day	0.02917	Gallons per minute
Centimeter	0.3937	Inches
Cubic centimeters	0.006102	Cubic inches
Cubic feet	1,728	Cubic inches
Cubic feet	0.03704	Cubic yards
Cubic feet	7.481	Gallons
Cubic feet	0.1781	Barrels (oilfield)
Cubic feet	28.3160	Liters
Cubic feet	0.03704	Cubic yards
Cubic feet per minute	0.4719	Liters per second
Cubic inches	16.3871	Cubic centimeters
Cubic yards	27	Cubic feet
Cubic yards	0.764555	Cubic meters
Degrees (angle)	0.01745	Radians
Degree Fahrenheit (degF)	(degF - 32) ÷ 1.8 or (degF - 32) × 5/9	Degree Celsius (degC)
Feet	30.48	Centimeters
Feet	12	Inches
Feet	0.3048	Meters
Feet	0.0001894	Miles
Feet of water (depth)	0.4335	Pounds per square inch
Feet	0.3048	Meters
Foot pounds	1.35582	Joules
Foot pounds	0.138255	Meter-kilograms
Furlongs	660	Feet
Gallons (imperial)	1.209	Gallons (U.S.)
Gallons (imperial)	4.54609	Liters
Gallons (U.S.)	3,785.434	Cubic centimeters
Gallons (U.S.)	0.02381	Barrels, oil
Gallons (U.S.)	0.1337	Cubic feet
Gallons (U.S.)	3.785	Liters
Gallons per minute	0.002228	Cubic feet per second
Gallons per minute	34,286	Barrels per day
Grains	64.79891	Milligrams

English and Metric

Multiply	By	To Obtain
Grains	0.03527	Ounces
Inches	0.08333	Feet
Inches	25.4	Millimeters
Inches of water	0.03613	Pounds per square inch
Kilometers	3,281	Feet
Kilometers	0.6214	Miles
Kilometers per hour	0.6214	Miles per hour
Knots	6,080	Feet
Knots	1.152	Miles per hour
Liters	0.03531	Cubic feet
Liters	0.2642	Gallons
Meters	3.281	Feet
Meters	39.37	Inches
Meters	1.094	Yards
Miles	5,280	Feet
Miles	1.609	Kilometers
Miles	1,760	Yards
Miles per hour	88	Feet per minute
Miles per hour	1.609	Kilometers per hour
Miles per hour	0.8684	Knots
Minutes	0.01667	Hours
Minutes (angle)	0.0002909	Radians
Minutes (angle)	60	Seconds (angle)
Ounces (fluid)	1.805	Cubic inches
Ounces per cubic inch	1.72999	Grams per cubic centimeter
Pascal	1.0	Newton per square meter
Pints	28.87	Cubic inches
Pints	0.125	Gallons
Pounds	453.6	Grams
Pounds	0.4536	Kilograms
Pounds of water	0.01602	Cubic feet of water
Pounds of water	27.68	Cubic inches of water
Pounds of water	0.1198	Gallons
Pounds per cubic foot	0.01602	Grams per cubic centimeter
Pounds per cubic foot	16.0185	Kilograms per cubic meter
Pounds per square foot	4.88241	Kilograms per square meter
Pounds per square foot	47.8803	Newtons per square meter
Pounds per square inch	2.307	Feet of water
Pounds per square inch	0.689476	Newtons per square centimeter
Quarts (U.S.)	57.75	Cubic inches
Quarts (U.S.)	57.75	Cubic centimeters
Quarts (U.S.)	0.946331	Liters
Radians	57.30	Degrees
Radians per second	9.549	Revolutions per minute
Square centimeters	0.1550	Square inches
Square feet	144	Square inches
Square feet	0.00002296	Acres
Square feet	929	Square centimeters
Square inches	6.4516	Square centimeters
Square inches	0.006944	Square feet
Square miles	640	Acres
Square miles	2.59	Square kilometers
Square kilometer	247.1	Acres
Square meters	10.76	Square feet
Square meters	0.0002471	Acres
Square yards	9	Square feet
Square yards	0.8361	Square meters
Temperature (degC)	1.8 (+32)	Temperature (degF)
Temperature (degF)	(-32) × 5/9 or 0.5556	Temperature (degC)
Tons (long)	2,240	Pounds
Tons (metric)	2,205	Pounds
Tons (short)	2,000	Pounds
Yards	0.9144	Meters
Yards	91.44	Centimeters

Reference

Buoyancy factor

Buoyancy Factor (k)

Mud Density			k	Mud Density			k
kg/L	lbm/galUS	lbm/ft ³		kg/L	lbm/galUS	lbm/ft ³	
1.00	8.35	62.4	0.873	1.62	13.52	101.2	0.793
1.02	8.51	63.7	0.869	1.64	13.68	102.4	0.791
1.04	8.68	64.9	0.867	1.66	13.85	103.7	0.789
1.06	8.85	66.2	0.864	1.68	14.02	104.9	0.786
1.08	9.01	67.4	0.862	1.70	14.18	106.2	0.783
1.10	9.18	68.7	0.859	1.72	14.35	107.4	0.781
1.12	9.31	69.9	0.857	1.74	14.52	108.7	0.779
1.14	9.51	71.2	0.854	1.76	14.68	109.9	0.776
1.16	9.68	72.4	0.852	1.78	14.85	111.2	0.773
1.18	9.85	73.7	0.849	1.80	15.02	112.4	0.771
1.20	10.01	74.9	0.847	1.82	15.18	113.7	0.768
1.22	10.18	76.2	0.844	1.84	15.35	114.9	0.765
1.24	10.35	77.47	0.842	1.86	15.53	116.2	0.763
1.26	10.52	78.7	0.839	1.88	15.69	117.4	0.760
1.28	10.68	79.9	0.837	1.90	15.86	118.7	0.758
1.30	10.85	81.2	0.834	1.92	16.02	119.9	0.755
1.32	11.02	82.4	0.832	1.94	16.18	121.2	0.752
1.34	11.18	83.7	0.829	1.96	16.36	122.4	0.749
1.36	11.35	84.9	0.827	1.98	16.53	123.7	0.747
1.38	11.52	86.2	0.824	2.00	16.69	124.9	0.745
1.40	11.68	87.4	0.822	2.02	16.86	126.2	0.742
1.42	11.85	88.7	0.819	2.04	17.02	127.4	0.739
1.44	12.02	89.9	0.817	2.06	17.18	128.7	0.737
1.46	12.18	91.2	0.814	2.08	17.36	129.9	0.734
1.48	12.35	92.4	0.812	2.10	17.53	131.2	0.732
1.50	12.52	93.7	0.809	2.12	17.69	132.4	0.729
1.52	12.68	94.9	0.837	2.14	17.86	133.7	0.727
1.54	12.85	96.2	0.804	2.16	18.02	134.9	0.725
1.56	13.02	97.4	0.801	2.18	18.19	136.2	0.722
1.58	13.18	98.7	0.798	2.20	18.36	137.4	0.719
1.60	13.35	99.9	0.796	2.22	18.54	138.7	0.717

Apparent weight = Real weight × Buoyancy factor

Hence, buoyancy factor (k) = $1 - \frac{\text{Mud density}}{\text{Steel density}}$

Reference

Fixed cutter bit nozzle installation

Correct nozzle installation helps prevent washouts.

- Remove the plastic plug and the O-ring from each nozzle port.
- Grease the O-ring and replace it in the O-ring groove.
- Do not grease nozzles in matrix bits before installation.
- Lightly grease nozzles in steel bits and screw into jet ports.
- Hand tighten the nozzle with a T-wrench until snug.

Damage may occur if a cheater bar is used on the T-wrench handle.

Nozzle and Port Size Availability for PDC Bits

Nozzle or Port Size, in	Nozzle Series				Port	
	30	40	50	60	Steel	Matrix
7/32	■		■	■		
8/32	■	■	■	■	■	■
9/32	■	■	■	■	■	■
10/32	■	■	■	■	■	■
11/32	■	■	■	■	■	■
12/32	■	■	■	■	■	■
13/32	■	■	■	■		■
14/32			■	■		■
15/32			■	■		■
16/32			■	■		■
17/32				■		
18/32				■		
19/32						
20/32				■		
21/32						
22/32				■		
Empty area	0.1503 in ²	0.1385 in ²	0.1963 in ²	0.3718 in ²		

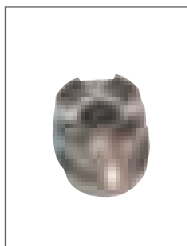

30 series.



40 series.

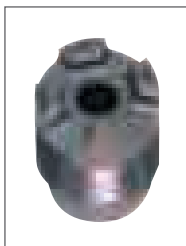

50 series.

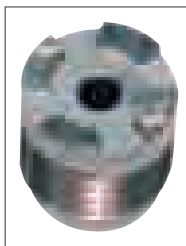

60 series.

Wrenches

Series 30: 60007986
 Series 40: 60018251
 Series 50: 60024519
 Series 60: 60003448
 Vortexx™ 60: 60005675

O-Ring series

Series 30: 60007985
 Series 40: 60007985
 Series 50: 60019245
 Series 60 and Vortexx™ 60: 60003276

Reference

Nozzle comparison chart

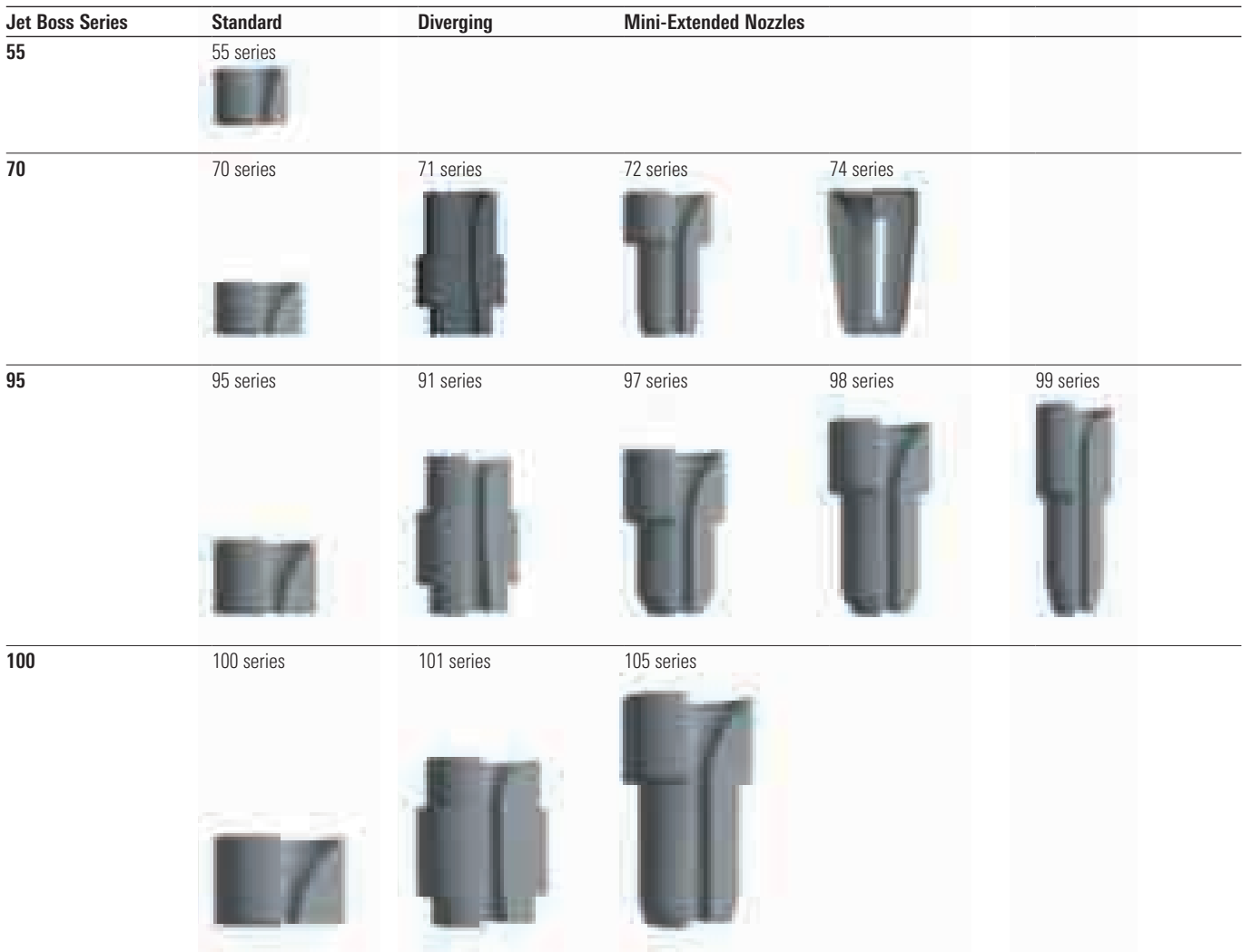

Physical Nozzle Size Availability Chart (Roller Cones)

Series	Nozzle Size, $\frac{x}{32}$ in																Empty Jet TFA, in ²			
	7	8	9	10	11	12	13	14	15	16	17	18	19	20	22	24		28	30	32
55	■	■	■	■	■	■	■	■	■	■										0.196
65	■	■	■	■	■	■	■	■	■	■		■		■						0.307
70	■	■	■	■	■	■	■	■	■	■		■		■	■	■				0.65
72	■	■	■	■	■	■	■	■	■	■										0.65
74		■	■	■	■	■	■	■	■	■		■		■						0.65
75		■	■	■	■	■	■	■	■	■		■		■	■	■	■			0.69
91		■	■	■	■	■	■	■	■	■										0.899
95	■	■	■	■	■	■	■	■	■	■		■		■	■	■	■	■	■	0.899
97	■	■	■	■	■	■	■	■	■	■		■		■	■	■				0.899
98	■	■	■	■	■	■	■	■	■	■		■		■						0.899
99		■	■	■	■	■	■	■	■	■		■		■	■					0.899
100		■	■	■	■	■	■	■	■	■		■		■	■	■	■	■	■	1.629
101						■	■	■	■	■		■		■	■	■				1.629
105						■	■	■	■	■		■		■	■	■	■			1.629

Reference

Roller cone diverging nozzle hydraulics chart

Physical Nozzle Size, in	Pressure Nozzle Size, in	Equivalent Pressure Area, in ²
$\frac{9}{32}$	$\frac{10}{32}$	0.077
$\frac{9}{32}$	$\frac{11}{32}$	0.093
$\frac{10}{32}$	$\frac{12}{32}$	0.110
$\frac{11}{32}$	$\frac{13}{32}$	0.130
$\frac{12}{32}$	$\frac{14}{32}$	0.150
$\frac{13}{32}$	$\frac{16}{32}$	0.196
$\frac{14}{32}$	$\frac{17}{32}$	0.222
$\frac{15}{32}$	$\frac{18}{32}$	0.249
$\frac{16}{32}$	$\frac{19}{32}$	0.277
$\frac{17}{32}$	$\frac{20}{32}$	0.307
$\frac{18}{32}$	$\frac{21}{32}$	0.338
$\frac{19}{32}$	$\frac{22}{32}$	0.371
$\frac{20}{32}$	$\frac{24}{32}$	0.442
$\frac{22}{32}$	$\frac{26}{32}$	0.518
$\frac{24}{32}$	$\frac{28}{32}$	0.601

Approximately 20% of the total flow should be programmed through center jet.

Note: For hydraulic calculations, determine the corresponding equivalent nozzle size for the specific diverging nozzle size.

For example $\frac{17}{32}$ in is the equivalent nozzle size in hydraulic calculations for a $\frac{10}{32}$ -in diffuser nozzle size.

Reference

Nozzle types and applications for roller cone bits

Bit Size Range, in	Milled Tooth (MT) Series		Jet or Air Series	TCI Series		All Three-Cone Bits			
	Open Bearing	Sealed Bearing	All	Sealed or Journal Bearing	TCT Bit Two-Cone Outer Jets	Full-Extended Tubes	Q-Tubes	Mini-Jets MT	TCI
3½–5½		55		55					
5½–6¾	70	70	70	70				72/74	72/74
7¾–7¾	95	95	95	95					
7¾–8¾	95	95	95	95	70			97	98
8½–8¾	95	95	95	95	70			97	98
9½–9¾	95	95	95	95	95			97	98/99
10½–12¼	95	95	95	95	95	70	95	97/98	98/99
13½–14¾	100	100		100	100	70	100	105	105
16–28	100	100		100	100	95	100	105	105

Center jet component list

Center Jet Retention Systems			
Bit Size Range, in	Three-Cone Open Bearing	Three-Cone Closed Bearing	TCT Bits
6½–6¾	65		
7½–7¾	70 long	70 long	70 long
7¾	70 long	70 long	70 long
8½–9	70 short	70 short	70 short
9½–14¾	95	95	95
16–20	100 short	100 short	100 short
22–28	100 long	100 long	100 long

Reference

6⁵/₈-in API pin restrictor nozzle

The pin restrictor nozzle is used in special applications for mud motors that require high bit pressure drops (650–850 psi) during operation. Pin restrictors are designed to split the total bit pressure drop between a nozzle in the pin and the bit jet nozzles. Installing a pin restrictor enables larger nozzles to be installed in the bit face, reducing the jet nozzle velocity and bit body erosion.

Pin restrictors are installed in the pin of the bit and require a modified pin for installation. The modification can be made on the bit when first built, or it can be retrofitted after the bit is manufactured. Two sleeves are designed to fit into the modified pin. A nozzle sleeve can be installed when a pin restrictor is required. A blank sleeve can be installed when no pin restrictor is required.

Pin restrictors do not run as efficiently as standard jet nozzles. A spreadsheet has been developed to aid in the selection of the pin restrictor and outer nozzle sizes. Contact your Smith Bits representative for the spreadsheet prior to running a pin restrictor nozzle in a bit.

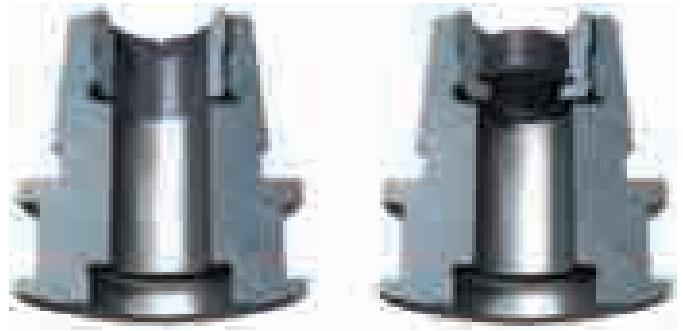

6⁵/₈-in API pin restrictor assembly with nozzles.

Reference

Maximum cone dimensions for three-cone rock bits and approximate bit weights

Maximum Cone Dimensions for Three-Cone Rock Bits			Approximate Bit Weights	
Size Range, in [mm]	Maximum Diameter, in [mm]	Maximum Length, in [mm]	Milled Tooth Approx. Weight, lbm [kg]	TCI Approx. Weight, lbm [kg]
3½–3¾ [89–98]	2¾ [60]	1¾ [41]	10 [5]	12 [5]
4¾ [121]	2¾ [73]	2¾ [54]	15 [7]	20 [9]
5¾–6¼ [149–150]	4¼ [108]	3¾ [79]	35 [16]	45 [20]
6½–6¾ [165–172]	4½ [114]	3½ [89]	45 [20]	55 [25]
7¾–8 [187–203]	5¼ [133]	4 [102]	75 [34]	85 [39]
8¾–8½ [206–216]	5¾ [149]	4¾ [105]	90 [41]	95 [43]
8¾–9 [219–229]	6¾ [156]	4¾ [117]	95 [43]	100 [45]
9¾–9½ [232–241]	6½ [165]	4¾ [111]	125 [57]	130 [59]
9¾–9¾ [245–251]	6¾ [171]	4¾ [121]	135 [61]	145 [66]
10–10¾ [254–270]	7¼ [184]	5½ [140]	165 [75]	175 [180]
11–11¾ [279–302]	7¾ [200]	5¾ [149]	195 [89]	210 [95]
12–12¼ [305–311]	8 [203]	6¾ [156]	205 [93]	225 [102]
13¼–15 [337–381]	9¾ [244]	7¾ [194]	345 [157]	380 [173]
16 [406]	10¼ [260]	8¾ [206]	410 [186]	450 [205]
17½ [445]	11½ [292]	8¾ [219]	515 [234]	545 [248]
18½ [470]	12 [305]	9 [229]	525 [239]	570 [259]
20 [508]	12½ [318]	9¾ [244]	625 [284]	700 [318]
22 [559]	13¾ [349]	10½ [267]	1,000 [455]	1,170 [532]
24 [610]	15¼ [387]	11¼ [286]	1,385 [629]	1,400 [636]
26 [660]	16 [406]	12¾ [324]	1,450 [659]	1,550 [704]
28 [711]	17 [432]	13 [330]	1,550 [704]	1,650 [750]

Reference

IADC dull bit grading

Cutting Structure				Bearings or Seals	Gauge	Other Dull Characteristics	Reason Pulled																														
Inner	Outer	Dull Characteristics	Location																																		
1	2	3	4	5	6	7	8																														
<p>1. Inner cutting structure (all inner rows) For fixed cutter bits, use the inner $\frac{2}{3}$ of the bit radius</p> <p>2. Outer cutting structure (gauge row only) For fixed cutter bits, use the outer third of the bit radius. In columns 1 and 2, a linear scale from 0 to 8 is used to describe the condition of the cutting structure according to the following:</p> <p>Steel tooth bits A measure of lost tooth height due to abrasion, damage, or both 0—No loss of tooth height 8—Total loss of tooth height</p> <p>Insert bits A measure of total cutting structure reduction due to lost, worn, and broken inserts 0—No lost, worn, or broken inserts 8—All inserts lost, worn, or broken</p> <p>Fixed cutter bits A measure of lost, worn, and broken cutting structure 0—No lost, worn, or broken cutting structure 8—All cutting structure lost, worn, or broken</p>				<p>4. Location</p> <p>Roller cone N—Nose row M—Middle row G—Gauge row A—All rows</p> <p>Cone number 123</p> <p>Fixed cutter C—Cone N—Nose T—Taper S—Shoulder G—Gauge A—All areas</p>		<p>6. Gauge Measure to nearest $\frac{1}{16}$ of an inch 1 in—In gauge 1—$\frac{1}{16}$ in—Out of gauge 2—$\frac{2}{16}$ in—Out of gauge 4—$\frac{4}{16}$ in—Out of gauge</p>		<p>7. Other Dull Characteristics Refer to column 3 codes</p>		<p>8. Reason Pulled or Run Terminated BHA—Changed bottomhole assembly DMF—Downhole motor failure DTF—Downhole tool failure DSF—Drillstring failure DST—Drillstem test DP—Drill plug CM—Condition mud CP—Core point FM—Formation change HP—Hole problems LIH—Left in hole HR—Hours on bit LOG—Run logs PP—Pump pressure PR—Penetration rates RIG—Rig repair TD—Total depth or casing depth TW—Twistoff TQ—Torque WC—Weather conditions</p>																											
<p>3. Dull characteristics (Use only cutting-structure-related codes)</p> <table border="0"> <tr> <td>BC[†]—Broken cone</td> <td>LC[†]—Lost cone</td> </tr> <tr> <td>BF—Bond failure</td> <td>LN—Lost nozzle</td> </tr> <tr> <td>BT—Broken teeth or cutters</td> <td>LT—Lost teeth or cutters</td> </tr> <tr> <td>BU—Balled-up bit</td> <td>OC—Off-center wear</td> </tr> <tr> <td>CC[†]—Cracked cone</td> <td>PB—Pinched bit</td> </tr> <tr> <td>CD[†]—Coned dragged</td> <td>PN—Plugged nozzle</td> </tr> <tr> <td>CI—Cone interference</td> <td>or flow passage</td> </tr> <tr> <td>CR—Cored</td> <td>RG—Rounded gauge</td> </tr> <tr> <td>CT—Chipped teeth or cutters</td> <td>RO—Ringout</td> </tr> <tr> <td>ER—Erosion</td> <td>SD—Shirttail damage</td> </tr> <tr> <td>FC—Flat-crested wear</td> <td>SS—Self-sharpening wear</td> </tr> <tr> <td>HC—Heat checking</td> <td>TR—Tracking</td> </tr> <tr> <td>JD—Junk damage</td> <td>WO—Washout</td> </tr> <tr> <td></td> <td>WT—Worn teeth or cutters</td> </tr> <tr> <td></td> <td>NO—No dull characteristics</td> </tr> </table>				BC [†] —Broken cone	LC [†] —Lost cone	BF—Bond failure	LN—Lost nozzle	BT—Broken teeth or cutters	LT—Lost teeth or cutters	BU—Balled-up bit	OC—Off-center wear	CC [†] —Cracked cone	PB—Pinched bit	CD [†] —Coned dragged	PN—Plugged nozzle	CI—Cone interference	or flow passage	CR—Cored	RG—Rounded gauge	CT—Chipped teeth or cutters	RO—Ringout	ER—Erosion	SD—Shirttail damage	FC—Flat-crested wear	SS—Self-sharpening wear	HC—Heat checking	TR—Tracking	JD—Junk damage	WO—Washout		WT—Worn teeth or cutters		NO—No dull characteristics	<p>5. Bearings or Seals</p> <p>Nonsealed bearings A linear scale estimating bearing life used 0—No life used 8—All life used (i.e., no bearing life remaining)</p> <p>Sealed bearings E—Seals effective F—Seals failed N—Not able to grade X—Fixed cutter bit (bearingless)</p>			
BC [†] —Broken cone	LC [†] —Lost cone																																				
BF—Bond failure	LN—Lost nozzle																																				
BT—Broken teeth or cutters	LT—Lost teeth or cutters																																				
BU—Balled-up bit	OC—Off-center wear																																				
CC [†] —Cracked cone	PB—Pinched bit																																				
CD [†] —Coned dragged	PN—Plugged nozzle																																				
CI—Cone interference	or flow passage																																				
CR—Cored	RG—Rounded gauge																																				
CT—Chipped teeth or cutters	RO—Ringout																																				
ER—Erosion	SD—Shirttail damage																																				
FC—Flat-crested wear	SS—Self-sharpening wear																																				
HC—Heat checking	TR—Tracking																																				
JD—Junk damage	WO—Washout																																				
	WT—Worn teeth or cutters																																				
	NO—No dull characteristics																																				

[†] Show cone number(s) under **Location** (4).

Reference

Stinger element dull bit grading

The unique conical geometry of the Stinger element requires a modified dull grading to measure damage observed (lost, worn, or broken). The wear rating scale (0 to 8) is the same as used for standard PDC cutters.



Stinger element wear can be recorded from a linear scale of WT0 to WT8, with 0 representing no wear and 8 representing no diamond table remaining.



WT—No wear (Level 0 severity).

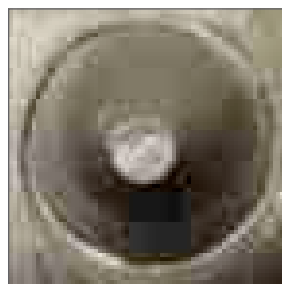

WT—Minimal wear (Level 1 severity).

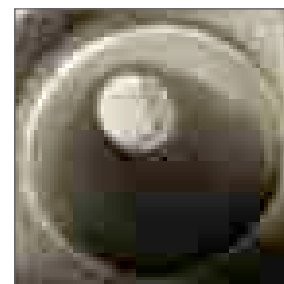

WT—Minor wear (Level 2 severity).

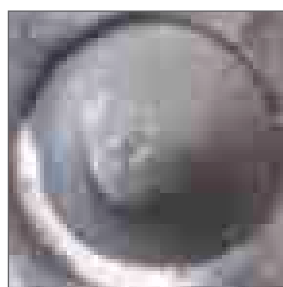

CT—Chipped element.

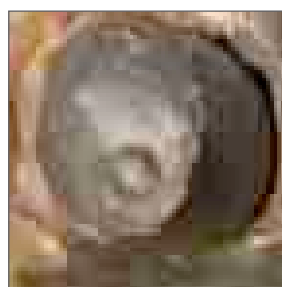

SP—Spalling.

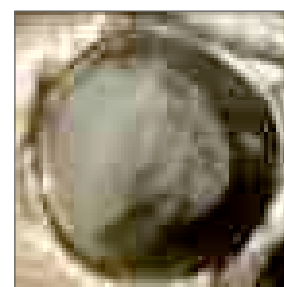

BT—Broken element.

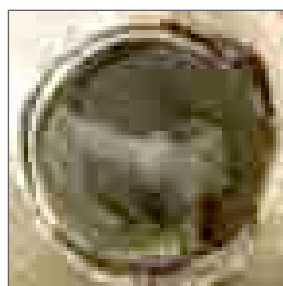

DL—Stinger element delamination.

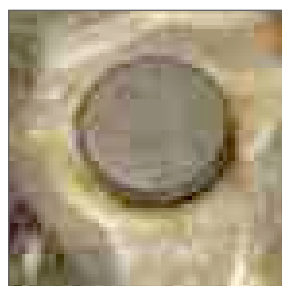

BF—Bond failure.

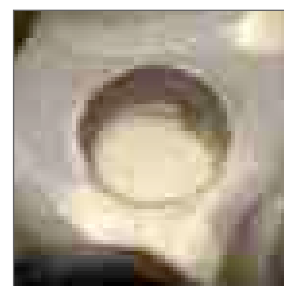

LT—Lost element.

*Mark of Schlumberger
Other company, product, and service names are the properties of their respective owners.
Copyright © 2018 Schlumberger. All rights reserved. 17-BDT-310907

slb.com/bits

SMITH BITS
A Schlumberger Company